



Operator's Instruction Manual

TG-10



TURBO GRINDERS

Available in Gasoline, Propane and Electric



100 Thomas Johnson Drive, Frederick, MD 21702-4600 USA
Phone: 301-638-3326 • 301-663-1600
Fax: 800-447-3326 • 301-663-1607
edcoinc.com • sales@edcoinc.com

EDCO

EQUIPMENT DEVELOPMENT CO., INC.

READ AND UNDERSTAND THE OPERATORS INSTRUCTION MANUAL *THOROUGHLY* BEFORE ATTEMPTING TO OPERATE THIS EQUIPMENT.



Death or serious injury could occur if this machine is used improperly.



SAFETY MESSAGES

- Safety Instructions are preceded by a graphic alert symbol of DANGER, WARNING, or CAUTION.



Indicates an imminent hazard which, if not avoided, will result in death or serious injury.



Indicates an imminent hazard which, if not avoided, can result in death or serious injury.



Indicates hazards which, if not avoided, could result in serious injury and or damage to the equipment.

GASOLINE/PROPANE POWERED EQUIPMENT



- Engine exhaust from this product contains chemicals known to the State of California to cause cancer, birth defects or other reproductive harm.

harm.

-  Gasoline is extremely flammable and poisonous. It should only be dispensed in well ventilated areas, and with a cool engine.
- Small gasoline engines produce high concentrations of carbon monoxide (CO) example: a 5 HP 4 cycle engine operation in an enclosed 100,000 cu. ft. area with only one change of air per hour is capable of providing deadly concentrations of CO in less than fifteen minutes. Five changes of air in the same area will produce noxious fumes in less than 30 minutes. Gasoline or propane powered equipment should not be used in enclosed or partially enclosed areas. Symptoms of CO poisoning include, headache, nausea, weakness, dizziness, visual problems and loss of consciousness. If symptoms occur - get into fresh air and seek medical attention immediately.

ELECTRICAL POWERED EQUIPMENT



Extreme care must be taken when operating electric models with water present: Ensure power cord is properly grounded, is attached to a Ground-Fault-Interrupter (GFI) outlet, and is undamaged.

- Check all electrical cables - be sure connections are tight and cable is continuous and in good condition. Be sure cable is correctly rated for both the operating current and voltage of this equipment.
- Improper connection of the equipment-grounding conductor can result in a risk of electric shock. Check with qualified electrician or service person if there is any doubt as to whether the outlet is properly grounded. Adhere to all local codes and ordinances.
- **NOTE:** In the event of a malfunction or breakdown, grounding provides a path of least resistance for the electric current to dissipate. The machine is equipped with a grounded plug and must be connected to an outlet that is properly installed and properly grounded. DO NOT modify the plug provided on the motor. If the plug does not fit the outlet have a qualified electrician install the proper receptacle.
- Switch motor OFF **before** disconnecting power.

- Do not disconnect power by pulling cord. To disconnect, grasp the plug, not the cord.
- Unplug power cord at the machine when not in use and before servicing.

GENERAL INSTRUCTIONS

- Equipment should only be operated by trained personnel in good physical condition and mental health (not fatigued). The operator and maintenance personnel must be physically able to handle the bulk weight and power of this equipment.
- This is a one person tool. Maintain a safe operating distance to other personnel. It is the **operators' responsibility** to keep other people (workers, pedestrians, bystanders, etc.) away during operation. Block off the work area in all directions with roping, safety netting, etc. for a safe distance. Failure to do so may result in others being injured by flying debris or exposing them to harmful dust and noise.
- This equipment is intended for commercial use only.
- For the operator's safety and the safety of others, always keep all guards in place during operation.
- Never let equipment run unattended.



- Personal Protection Equipment and proper safety attire must be worn when operating this machinery. The operator must wear approved safety equipment appropriate for the job such as hard hat and safety shoes when conditions require. Hearing protection **MUST** be used (operational noise levels of this equipment may exceed 85db). Eye protection **MUST** be worn at all times.



Keep body parts and loose clothing away from moving parts. Failure to do so could result in dismemberment or death.

- Do not modify the machine.
- Stop motor/engine when adjusting or servicing this equipment. Maintain a safe operating distance from flammable materials. Sparks from the cutting-action of this machine can ignite flammable materials or vapors.



DUST WARNING



Some dust created by power sanding, sawing, grinding, drilling, and other construction activities contains chemicals known to cause cancer, birth defects, or other reproductive harm. Some examples of these chemicals are:

- Lead from lead-based paints, and
- Crystalline silica from bricks and concrete and other masonry products.

Your risk of exposure to these chemicals varies depending on how often you do this type of work. To reduce your risk: work in a well ventilated area, use a dust control system, such as an industrial-style vacuum, and wear approved personal safety equipment, such as a dust/particle respirator designed to filter out microscopic particles.



Operator's Instruction Manual TG-10 TURBO GRINDERS

Table of Contents

Safety Information 2
 Table of Contents and Specifications 3
 Safety Guidelines 4
 Operating Instructions 5-8
 Quick Change Multi-Accessory Disc Accessories 9
 Maintenance 10-11
 Maintenance Schedule 12
 SMI Dust and Silica Warning 13
 Notes 14
 Limited Equipment Warranty Inside Back Page



NOTE: Due to improvements your machine may not appear the same as the pictures in this manual.

Figure 1

HOW TO ORDER REPAIR PARTS

To insure product safety and reliability, always use genuine EDCO replacement parts when making repairs to the equipment.

When ordering parts, please specify the MODEL and SERIAL NUMBER of the machine as given on the NAMEPLATE. In addition, give part number, description and quantity as listed on the parts list.

Please note: Due to improvements and changes in the equipment the illustrations shown may be different from the actual machine.

Toll Free: Voice 1-800-638-3326 • Fax 1-800-447-3326

Specifications & Dimensions are for reference only and subject to change.

Model	TG10-5B	TG10-11H	TG10-13P
Length (L)	41"/104cm	41"/104cm	41"/104cm
Width (W)	24"/61cm	24"/61cm	24"/61cm
Height (H)	38"/97cm	38"/97cm	38"/97cm
Total Weight	175 lbs.	180 lbs.	220 lbs.

Weights include 10" Diamond Disc (20 Segments)



Read and understand all operating instructions
before operating this equipment.



Death or serious injury can result if this machine is used improperly.



Safety Guidelines



Eye and ear protection must be worn at all times while the grinder is in use. During normal operation, sound pressure levels may exceed 85dBA. Use only ANSI approved safety glasses to help prevent eye injury. Everyday eyeglasses have only impact resistant lenses; they are NOT safety glasses.



Operator must wear appropriate clothing and footwear. Do not wear loose clothing or jewelry that can get tangled in moving parts. Footwear should provide sure footing and protection.



Materials being removed can be toxic or hazardous. A breathing respirator is required to help protect the operator from inhaling the airborne material when operating this machine.

- Inspect the work surface for cracks, uneven joints and foreign objects such as nails, screws and pipes. Damage to the disc and/or equipment may result which can also cause serious injury to the operator. Hazardous areas should be properly identified and clearly marked.
- The TG-10 is designed to be controlled by a single operator .
- Inspect the discs carefully before installing. Do not use **any** questionable disc since serious personal injury and/or damage to property can result.
- Never operate this grinder while under the influence of drugs, alcohol or when taking medications that impair the senses or reactions, or when excessively tired or under stress.
- Be sure decals on the machine can be clearly read and understood. Replace worn or missing decals immediately,

Safety warnings and guidelines do not by themselves eliminate danger. They are not given as substitutes for proper accident prevention procedures and good judgement.



Operating Instructions



Exhaust from this engine contains Carbon Monoxide, an invisible, odorless gas that can kill. In addition, it contains chemicals known, in certain quantities, to cause cancer, birth defects or other reproductive harm.

Before Operating:

- **Visually inspect machine:**

- Verify all guards are in place and fasteners are tight.
- Check engine oil level (gasoline/propane models).
- Inspect power cord for damage and check for proper grounding (electric models).

- **Inspect disc assembly:**

- Check discs for damage or wear.
- Check mounting hardware.
- Check belt tension after first 4 hours of use with factory new equipment or after installing new belts.

- **Inspect the work area:**

Inspect work area carefully before starting to grind. EDCO will not be held responsible for damage to the discs caused by striking protruding slab inserts, nails, screws, pipe extensions, machinery bases, or other objects that transmit sudden shocks.

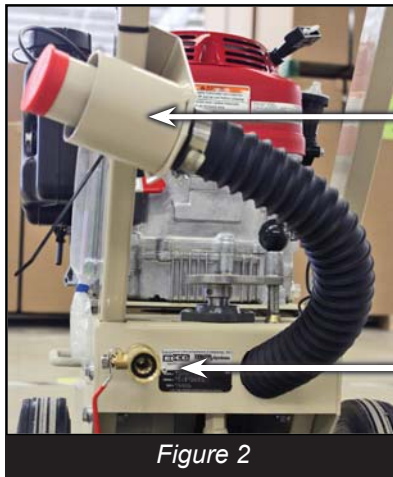

Figure 2

- **If dry grinding:**

- Hook up heavy-duty vacuum.

- **NOTE:**

Do not use dry vacuum when wet grinding.

- **If wet grinding:**

- Attach hose to water supply.

Important Reminder!

A water mist system or an industrial vacuum *must* be used while operating this equipment and the operator must wear a respirator. Failure to comply could lead to serious illness and possible death.

Safety warnings and guidelines do not by themselves eliminate danger. They are not given as substitutes for proper accident prevention and good judgement.



Gasoline Models: (11 HP Honda Engine)

To Start the Engine:

- Tilt the machine back slightly to allow the disc to clear the slab surface.
- Start the engine according to the directions in the engine manufacturer's Owner's Manual.

NOTE: If during operation refueling becomes necessary, allow the engine to cool down. NEVER refuel a hot engine.

To Stop the Gasoline Model:

- Tilt the machine back slightly to allow the disc to clear the slab surface.
- Turn the engine off.

To STOP engine - Press Emergency Stop Switch to OFF position
Press to ON position when re-starting Engine (*Figure 3*)

Propane Models: (13 HP Honda Engine with 110V Key Start)



Propane is extremely flammable. VAPOR ONLY

To Start the Engine:

- Ensure that tank is positioned properly (arrow  up).
- Turn on main valve on tank & Emergency Stop switch on handle.
- If you detect a gas odor immediately shut off engine and consult your operator's manual.
- Turn key to START
- Open throttle completely until engine runs smooth.
- Adjust throttle back to idle and sit machine back on surface.
- Increase speed to operating position & begin grinding.

To Stop the Propane Model:

NOTE: If engine stops abruptly (uncontrolled stop) or using E-STOP wait several minutes for propane gas to clear the fuel system and carburetor before trying to re-start.

- Tilt machine back slightly to allow the disc to clear the slab surface.
- If stopping for the day close valve and allow machine to purge propane from system.
- Turn key and emergency switch off.
- Otherwise just turn key off.

Electric Models: (5 HP Baldor. Available in 1 Phase or 3 Phase)



Electric units must be connected to a properly grounded electrical system using an approved electrical cable.

To Start the Motor:

- Tilt the machine back slightly, just enough for the disc to clear the slab surface.
- On 5 HP, single phase turn to the ON position. On the 5 HP, three phase, press the ON button.
- Be sure to check motor for correct rotation.
- Gently set the machine back down until the disc touches the slab surface and begin moving the machine.

NOTE: If the machine stops suddenly return the rotary can switch or starter box to the off position before pressing the manual reset on the motor.



Figure 3



To Stop the Electric Model:

- Tilt the machine to allow the disc to clear the slab surface.
- Turn rotary switch to the OFF position or press OFF button on the starter box.

Wet Grinding:

- In the wet grinding stage - water is fed from a standard garden hose into a ball valve cut off, then into a nozzle that sprays over the disc assembly. (Figure 4)
Use the ball valve to regulate the flow of water to the disc.



Only use enough water flow to reduce dust. Excess water flow will create clean up problems and could cause a hazardous walking area.



Always use dust control when using this product, vacuum or water mist.



Figure 4

Dry Grinding:



Dry Grinding creates a large volume of airborne dust. For health reasons, the operator should wear an applicable respirator. The dust may contain chemicals known to cause serious illnesses, including Silicosis - a fatal disease of the lungs. Check the chemical properties of the material to be removed and follow all EPA/OSHA regulations.

Controlling the Grind:

- Grinding discs are **extremely** aggressive. It is important to **KEEP THE GRINDER MOVING IN A SIDE-TO-SIDE MOTION**, do not let the grinder stay in one spot, even for a few seconds, or the surface will be damaged. When grinding is completed, tilt the machine back and shut off the power.
- To achieve a smooth “polished” surface, complete the grinding operation with an EDCO dual disc unit using grinding stones or dyma-serts.
- To remove a light coating, move the grinder quickly. For heavier removal, move the grinder more slowly.
- Keep the grinding disc flat - do not attempt to grind against vertical surfaces. Be sure the machine is in the correct operating position. (See Figure 5)



Figure 5

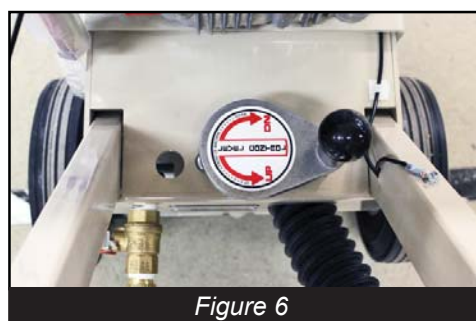

Figure 6



Comments in paragraph below are in reference to this level adjustment control (Figure 6).

NOTE: Ensure when leveling the machine as explained below that it (the machine) is sitting on a **FLAT LEVEL** surface otherwise adjustments may not be correct for the surface being worked on.

If rear of grinding disc is higher (not touching the work surface) than the front of the disc (touching the work surface) turn this control (Figure 7) counter clockwise until disc sits level (flat) on the work surface.

If front of grinding disc is higher (not touching the work surface) than the rear of the disc (touching the work surface) turn this control (Figure 7) clockwise until disc sits level (flat) on the work surface.

Do a light touch pass after each adjustment looking for a complete circle from the disc.

Discs:

- Inspect the disc (Figure 7) periodically to determine it's wear characteristics, if signs of uneven wear appear the cause should be determined and corrected. If repairs are needed contact EDCO or your EDCO representative.
- Rigid Head** can be used on uneven expansion joints, high spots, joint curls and bridge decks, removing coatings and grinding rough concrete surfaces. Use with a vacuum or water for dust control but not the same time. (Figure 8)
- Flex Head** can be used preparing a smooth, flat floor to receive a new coating, removing coatings, grind rough concrete surfaces. Can be used with a vacuum or water for dust control but not the same time. (Figure 9)



Figure 7
Disc shown is for reference only.

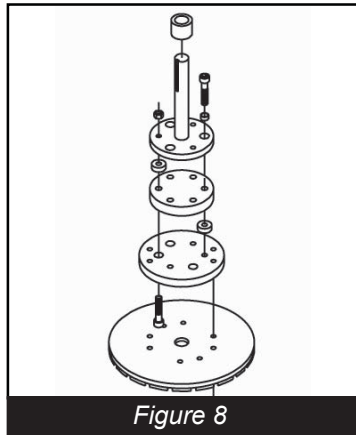

Figure 8
Standard RIGID HEAD

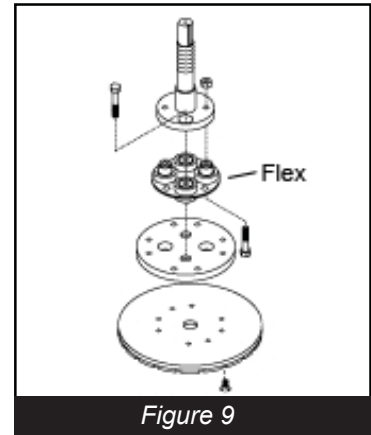

Figure 9
Optional FLEX HEAD

- This unit comes standard with a 10" Diamond Disc. Optional 6 pocket Mult-Accessory disc can be supplied. This allows for the use of low profile grinding tools.
NOTE: The low profile tooling can be used in either a 6 tool set up or a 3 tool set up. If only using 3 tools make sure they are evenly spaced on the disc.
- Each new machine is shipped with a RIGID HEAD (FLEX HEAD OPTIONAL) 10"/255 mm factory balanced disk. It is important to maintain the coupling to which the disk is attached. A worn coupling, damaged bearings or a bent shaft will cause the grinding discs to wear unevenly. (Figure 8 rigid head assembly & 9 flex head assembly.) It is important to note FLEX HEAD for smooth flat surfaces, RIGID HEAD for buckled, bumpy or rough surfaces.



FOR USE WITH QUICK-CHANGE MULTI-ACCESSORY DISC



DOUBLE DIAMOND DOTS: General Purpose Grind - Removes general purpose epoxy, mastics, thinsets, water-proofing coatings and more.



SINGLE DIAMOND DOTS: Aggressive Grind - Grinds and removes thick epoxies, weather-proofing membrane and other coatings.

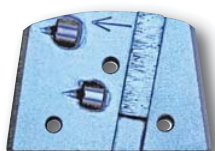

PCD ACCESSORY: Extremely Aggressive Removal - Digs through industrial strength coverings, water-proofing membranes, thick epoxies and much more - *Leaves a textured concrete surface.*



EDCO ARROW: Hard glue removal, fast coating removal, create smooth surfaces and more



PEAKS: General Purpose Grind - Smooths surfaces with fewer scratches - Ideal for concrete preparation and polishing. Removes thinsets, concrete coatings and more



Maintenance

Follow the engine manufacturer's guidelines for regular maintenance.

WARNING

Disconnect spark plug lead (*Figure 10*) before performing any maintenance on this machine! Or on the electric model, unplug the electric cord at the machine (instead of at the wall) to assure the machine will remain un-plugged while you are working on it.

Inspect Every 8 Hours:

- Inspect the disc mounting screws. (*Figure 11*) The constant vibration and heat generated, especially when grinding dry, could cause the screws to loosen and the disc to become off balance.

After every use:

- Inspect for lash in head (Does head move up/down)? (*Figure 12*). Verify that jam nuts, items 8 on page 10 in Parts Breakdown are tight and there isn't any play. Allowing these nuts to remain loose can damage the head assembly.
- If movement is noticed, STOP. Damage to head assembly may occur. In order to tighten these nuts the sheave under the hood must be removed. Bottom nut should be tightened and then backed off until head turns freely. Then top nut should be tightened down and jammed using two wrenches turning in opposite directions. After tightening make sure head still turns freely.

Lubricate Weekly:

- Bearings (*Figure 13*) must be lubricated weekly with Lubriplate 930-AA High Temp Grease or equivalent.
- Access fitting through opening on hood.

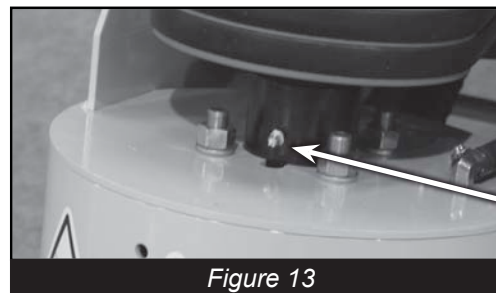
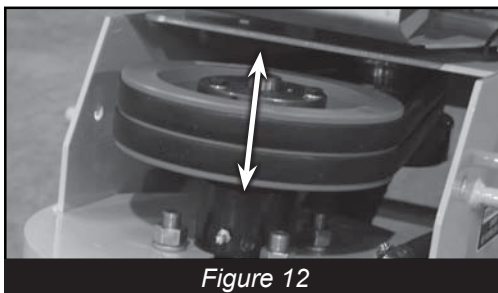
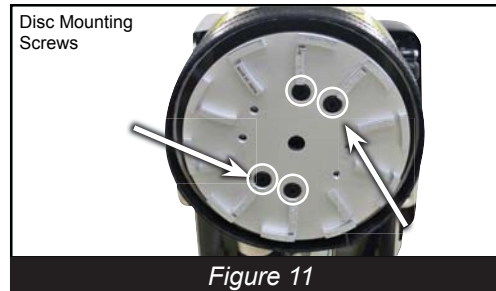
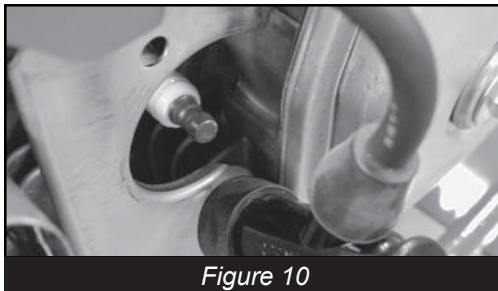



Maintenance

Belts:

To remove/replace belts:

- Remove belt cover to expose belts. (Figure 14)
- Loosen engine/motor mounting bolts (Figure 15) on both sides of the TG-10 and slide engine forward to allow belts to slide off.
- **Replace worn belts with a complete set of new belts** - even if only one belt is showing wear.
- Slide engine back in place until belts are tight and retighten engine mounting bolts.
- Reinstall belt cover and tighten hardware.
- After four hours of use, retighten belts.

Engine Air Filter:

Inspect the air filters (Figure 16) for excess dust, dirt or damage before the engine is operated. More often if operating in a dusty environment.

Operating the engine with a damaged or dirty air filter, or without an air filter, will allow dirt to enter the engine causing rapid engine wear which would not be covered under the engine manufacturer's warranty.

Follow the engine manufacturer's procedures for keeping the filters in good condition.

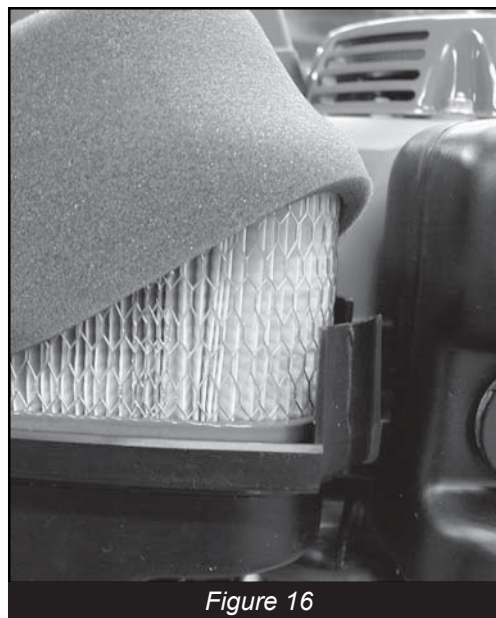
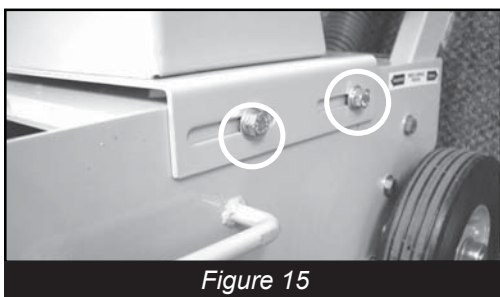
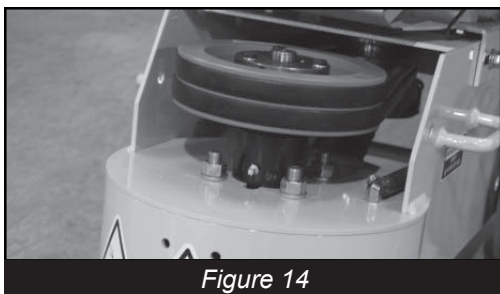



Read and follow the engine manufacturer's maintenance schedule.



Repairs are to be done by authorized EDCO Dealers only.

Maintenance Schedule

	Before Operation	After First 4 Hours	Every 8 Hours	Weekly	As Necessary
Inspect/tighten Jam nuts on head assy.				X	
Inspect Entire Machine	X				
* Check Oil & Fuel Levels	X				
* Check Air Filter (Clean if Necessary)	X				
* Inspect Propane Connections	X				
Inspect Disc	X				
Inspect Belt Tension		X			X
Lubricate Shaft Bearings				X	
Inspect/Tighten Disc Mounting Screws			X		X
Adjust Wheel Height					X
* Inspect Vacuum (empty bins, etc.)					X

* When applicable.



SMI Dust and Silica Warning

Grinding/cutting/drilling of masonry, concrete, metal and other materials can generate dust, mists and fumes containing chemicals known to cause serious or fatal injury or illness, such as respiratory disease, cancer, birth defects or other reproductive harm. If you are unfamiliar with the risks associated with the particular process and/or material being cut or the composition of the tool being used, review the material safety data sheets and/or consult your employer, the manufacturers/suppliers, governmental agencies such as OSHA and NIOSH and other sources on hazardous materials. California and some other authorities, for instance, have published lists of substances known to cause cancer, reproductive toxicity, or other harmful effects.

Control dust, mist and fumes at the source where possible. In this regard use good work practices and follow the recommendations of the manufacturers/suppliers, OSHA/NIOSH, and occupational and trade associations. Water should be used for dust suppression when wet grinding/cutting/drilling is feasible. When the hazards from inhalation of dust, mists and fumes cannot be eliminated, the operator and any bystanders should always wear a respirator approved by NIOSH/MSHA for the material being used.

Grinding/cutting/drilling of masonry, concrete and other materials with silica in their composition may give off dust or mists containing crystalline silica. Silica is a basic component of sand, quartz, brick clay, granite and numerous other minerals and rocks. Repeated and/or substantial inhalation of airborne crystalline silica can cause serious or fatal respiratory diseases, including silicosis. In addition, California and some other authorities have listed respirable crystalline silica as a substance known to cause cancer. When grinding/cutting/drilling such materials, always follow the respiratory precautions mentioned above.



LIMITED EQUIPMENT WARRANTY OF SALE – TERMS & CONDITIONS

Equipment Development Company, Inc. herein referred to as EDCO (Seller) warrants that each new unit manufactured by EDCO to be free from defects in material and workmanship in normal use and service for a period of (1) one year (except for the cutter drum assembly on all model concrete/asphalt planes, in which case the warranty period shall be 90 days) from date of shipment to the original retail or equipment rental center owner.

Accessories or equipment furnished and installed on the product by EDCO but manufactured by others, including, but not limited to engines, motors, electrical components, transmissions etc., shall carry the accessory manufacturers own warranty.

EDCO will, at its option, repair or replace, at the EDCO factory or at a point designated by EDCO, any part which shall appear to the satisfaction of EDCO inspection to have been defective in material or workmanship.

EDCO reserves the right to modify, alter and improve any part or parts without incurring any obligation to replace any part or parts previously sold without such modified, altered or improved part or parts.

This warranty is in lieu of and excludes all other warranties, expressed, implied, statutory, or otherwise created under applicable law including, but not limited to the warranty of merchantability and the warranty of fitness for a particular purpose in no event shall seller or the manufacturer of the product be liable for special, incidental, or consequential damages, including loss of profits, whether or not caused by or resulting from the negligence of seller and/or the manufacturer of the product unless specifically provided herein. In addition, this warranty shall not apply to any products or portions there of which have been subjected to abuse, misuse, improper installation, maintenance, or operation, electrical failure or abnormal conditions and to products which have been tampered with, altered, modified, repaired, reworked by anyone not approved by seller or used in any manner inconsistent with the provisions of the above or any instructions or specifications provided with or for the product

FORCE MAJEURE

Seller's obligation hereunder are subject to, and Seller shall not be held responsible for, any delay or failure to make delivery of all or any part of the Product due to labor difficulties, fires, casualties, accidents, acts of the elements, acts of God, transportation difficulties, delays by a common carrier, inability to obtain Product, materials or components or qualified labor sufficient to timely perform part of or all of the obligations contained in these terms and conditions, governmental regulations or actions, strikes, damage to or destruction in whole or part of manufacturing plant, riots, terrorist attacks or incidents, civil commotions, warlike conditions, flood, tidal waves, typhoon, hurricane, earthquake, lightning, explosion or any other causes, contingencies or circumstances within or without the United States not subject to the Seller's control which prevent or hinder the manufacture or delivery of the Products or make the fulfillment of these terms and conditions impracticable. In the event of the occurrence of any of the foregoing, at the option of Seller, Seller shall be excused from the performance under these Terms and Conditions, or the performance of the Seller shall be correspondingly extended.

This document sets forth the terms and conditions pursuant to which the purchaser ("Purchaser") will purchase and Equipment Development Co. Inc. ("Seller") will sell the products, accessories, attachments (collectively the Products) ordered by the Purchaser. These terms and conditions shall govern and apply to the sale of Seller's Products to Purchaser, regardless of any terms and conditions appearing on any purchase order or other forms submitted by Purchaser to Seller, or the inconsistency of any terms therein and herein.

1. PRICE

All prices set forth on any purchase order or other document are F.O.B. Sellers facility or distribution point, as may be determined by Seller (F.O.B. Point). All prices are exclusive of any and all taxes, including, but not limited to, excise, sales, use, property or transportation taxes related to the sale or use of the Products, now or hereafter imposed, together with all penalties and expenses. Purchaser shall be responsible for collecting and/or paying any and all such taxes, whether or not they are stated in any invoice for the Products. Unless otherwise specified herein, all prices are exclusive of inland transportation, freight, insurance and other costs and expenses relating to the shipment of the Products from the F.O.B. point to Purchaser's facility. Any prepayment by Seller of freight insurance and other costs shall be for the account of Purchaser and shall be repaid to Seller.

2. PAYMENT TERMS

Payment terms are as follows. 2% 10 days (to approved and qualified accounts). Net 30 days. This is a cash discount for invoices paid within 10 days after the invoice date, regardless of date of receipt of shipment. This is not a trade discount and will not be granted to accounts that do not adhere to stated terms.

*All past due accounts are subject to a late payment fee of 1.5% per month or a maximum allowed by law if different, along with the expenses incidental to collection including reasonable attorney's fees and costs.

*Seller reserves the right to hold shipments against past due accounts.

*Seller reserves the right to alter payment terms.

3. FREIGHT TERMS

All shipments will be made F.O.B. shipping point as designated in these Terms and Conditions, and title shall pass at the F.O.B. point. Delivery to the initial common carrier shall constitute delivery to the Purchaser. Any claims for loss or damage during shipment are to be filed with carrier by the Purchaser. Seller will not assume responsibility for the performance of the carrier.

Back orders will be shipped in the most practical fashion with charges consistent with our freight policy established with the original order. UPS, FED EX, MAIL or shipments by other couriers are subject to the same terms and conditions as outlined in paragraph #3 "Freight Terms".

4. DELIVERY, DAMAGES, SHORTAGES

Seller shall use reasonable efforts to attempt to cause the Products to be delivered as provided for in these Terms & Conditions. Delivery to the initial common carrier shall constitute the delivery to the Purchaser. Seller's responsibility, in so far as transportation risks are concerned ceases upon the delivery of the Products in good condition to such carrier at the F.O.B. point and all the Products shall be shipped at the Purchaser's risk. Seller shall not be responsible or liable for any loss of income and/or profits, or incidental, special, consequential damages resulting from Seller's delayed performance in shipment and delivery.

5. RETURN OF DEFECTIVE PRODUCTS

Defective or failed material shall be held at the Purchaser's premises until authorization has been granted by Seller to return or dispose of Products. Products that are to be returned for final inspection must be returned Freight Prepaid in the most economical way. Credit will be issued for material found to be defective upon Seller's inspection based on prices at time of purchase.

6. PRODUCTS ORDERED IN ERROR

Products may be returned, provided that claim is made and Seller is notified within 7 days of receipt of Products, and the Products are in original buyer's possession not more than 30 days prior to return, subject to Seller's approval. If Products are accepted for return, they must be Freight Prepaid and buyer will be charged a minimum of 15% restocking charge, plus a charge back for outbound freight charges if the original order was shipped prepaid. Returns are not accepted for any Products that are specifically manufactured to meet the buyer's requirement of either specifications or quantity.

AGREEMENTS

These Terms and Conditions constitute the entire agreement between Seller and Purchaser as it relates to terms and conditions of sale, and supersedes any and all prior oral or written agreements, correspondence, quotations or understandings heretofore in force between the parties relating to the subject matter hereof. There are no agreements between Seller and Purchaser with respect to the Product herein except those specifically set forth in and made part of these terms and conditions. Any additional terms, conditions and/or prices are rejected by Seller.

These terms and conditions may be modified, cancelled or rescinded only by a written agreement of both parties executed by their duly authorized agents.

USE ONLY GENUINE EDCO PARTS & ACCESSORIES
For your own safety, the safety of others and the life of your machine.



**SURFACE PREPARATION, RESTORATION, PROFESSIONAL
SAWING EQUIPMENT & HAND HELD TOOLS**

100 THOMAS JOHNSON DRIVE, FREDERICK, MD 21702

PHONE: 800-638-3326 OR 301-663-1600

Fax: 800-447-3326 or 301-663-1607

Email: sales@edcoinc.com

Website: edcoinc.com

Patents Pending & Issued



Created 5 2014

Printed in USA ©2015