

SAFETY AND OPERATIONS INSTRUCTIONS FROM:



PLEASE READ THIS INFORMATION CAREFULLY PRIOR TO
OPERATING EQUIPMENT

Notice to Operators

IF YOU CAN NOT READ OR DO NOT FULLY UNDERSTAND THE CONTENTS OF THIS MANUAL, PLEASE CONTACT THE FACTORY FOR PROPER ASSISTANCE BEFORE ATTEMPTING TO OPERATE THIS PRODUCT.

SI TU NO PUEDES LE'ER O NO COMPRENDES EL CONTENIDO DE ESTE MANUAL FAVOR DE PONERSE EN CONTACTO CON LA FABRICA PARA ASISTENCIA- A PROPIA ANTES DE INTENTAR PARA OPERAR ESTE PRODUCTO.

SOLLTEN SIE DIESE GEBRAUCHSANWEISUNG NICHT LESEN KOENNEN ODER ES NICHT VOLLKOMMEN VERSTEHEN, WENDEN SIE SICH BITTE AN DEN HERSTELLER FUER RICHTIGE HILFE EHE SIE VERSUCHEN DIESES PRODUKT ZU OPERIEREN.

SI VOUS NE LISEZ OU NE COMPRENDRE ENTIEREMENT LES MATIERES DE CE MANUEL, S'IL VOUS PLAIT, CONTACTEZ L'USINE POUR L'ASSISTANCE APPROPRIEE AVANT D'UTILISER LE PRODUIT.

DANGER

DANGER indicates a hazard with a high level of risk which, if not avoided, will result in death or serious injury.

WARNING

WARNING indicates a hazard with a medium level of risk which, if not avoided, could result in death or serious injury.

CAUTION

CAUTION indicates a hazard with a low level of risk which, if not avoided, could result in minor or moderate injury.

These safety alert symbols identify important safety messages in this manual. When you see these symbols, be alert to the possibility of personal injury and carefully read the message that follows.

Do not allow anyone to operate the RIP-R-STRIPPER without first reading this Operator Manual and becoming familiar with its operation. The manufacturer of this RIP-R-STRIPPER has gone to great extremes to provide the owner(s) and/or operator(s) with the finest equipment available for its intended job function. Yet, the possibility exists that the RIP-R-STRIPPER can be utilized in and/or subjected to job applications not perceived and/or anticipated by the manufacturer. Such misuse and/or misapplication of the RIP-R-STRIPPER can lead to the possibility of serious damage, injury or even death. It is the responsibility of the owner(s) and/or operator(s) to determine that the RIP-R-STRIPPER is being utilized and/or operated within the scope of its intended job function. It is the responsibility of the owner(s) and/or operator(s) to establish, monitor and constantly upgrade all safety programs and/or practices utilized in and for the operation of the RIP-R-STRIPPER. The purpose of such programs is to provide for owner(s) and/or operator(s) safety. Operators must be instructed to recognize and avoid unsafe conditions associated with their work (29 CFR 1926.21 (b)(2)) and/or applicable updated revisions. It is the responsibility of the owner(s) and/or operator(s)

to determine that no modifications and/or alterations have been made to the RIP-R-STRIPPER. Modifications and/or alterations can lead to the possibility of serious damage, injury or even death. It is the responsibility of the owner(s) and/or operator(s) to make this Operator Manual available for consultation during all phases of operation. Refer to OSHA 2207 which contains all OSHA job safety and health rules and regulations (1926 and 1910) covering construction.

CAUTION

The concept of portable, electrically-powered, floor covering removal equipment has been successfully utilized for over many years as a practical solution to many types of floor covering removal requirements. The basic concept is proven and well accepted within the associated marketplaces as an alternative method to manual labor. Use of a RIP-R-STRIPPER requires strenuous work activity. This type of work activity can be considered to be greater in magnitude than that experienced with the use of many other types of both light construction and lawn and garden related equipment. This type of work activity should only be attempted by operators of adequate physical size and stature, mental awareness and physical strength and condition. The body parts most noticeably affected during the covering removal process are the arms, hands, wrists, shoulders, lower back and legs. The process can also produce excessive stress/strain directly to the back muscles, spinal vertebrae and many other body parts. Back and wrist related pain can be side effects of utilizing a RIP-R-STRIPPER. A potential operator with a chronic back related problem or a history of back and/or other medically related problems should not attempt to utilize the RIP-R-STRIPPER. Use of the RIP-R-STRIPPER may only aggravate this and any other medically related problem. Because of the diverse types of prevailing job applications, job site conditions, operator experience levels and operator physical characteristics, no warranty, guarantee, representation and/or liability is made by the factory as to the absolute correctness or sufficiency of any operational procedure, operational position and/or technique. There is no absolute guarantee that an operator of any given experience level, physical size and/or physical condition will be immune to the possibility of and/or probable physical side effects of the normal use of the RIP-R-STRIPPER. Each potential operator must be made aware of and assume the operational and physical liability described and/or associated with the use of the RIP-R-STRIPPER. Improper use of the RIP-R-STRIPPER can result in property damage and/or personal injury, including death. Each potential operator not willing to assume the operational and physical liability described and/or associated with the use of the RIP-R-STRIPPER should not operate it. Proper levels of operator experience, skill and common sense are essential for maximizing the safe and efficient operation of the RIP-R-STRIPPER.

Record the RIP-R-STRIPPER serial number in the spaces provided below.

_____ **Model Number** _____ **Serial Number** _____ **Date of Purchase**

Specifications and design are subject to change without notice or obligation. All specifications are general in nature and are not intended for specific application purposes. General Equipment Company reserves the right to make changes in design, engineering or specifications and to add improvements or discontinue manufacture at any time without notice or obligation. General Equipment Company and its agents accept no responsibility for variations which may be evident in actual products, specifications, pictures and descriptions contained in this publication.

Operator Instructional Data Sheet

The following undersigned operators of the RIP-R-STRIPPER described and/or pertaining to this Operator Manual have received formal safety and operational information/instruction from the undersigned owner(s)/instructor(s) in accordance to OSHA 29 CFR 1926.21 (b)(2) and/or applicable updated revisions pertaining to, but not necessarily limited to the:

- 1) READING, COMPREHENSION AND ACKNOWLEDGEMENT OF THE MATERIAL COMPRISING THE ENTIRE CONTENTS OF THE APPLICABLE OPERATOR MANUAL FOR THE RIP-R-STRIPPER.**
- 2) FORMALIZED OPERATOR'S SAFETY PROGRAM TO BE DEvised BY THE OWNER OF THE RIP-R-STRIPPER IN CONJUNCTION WITH THE CONTENTS OF THE APPLICABLE OPERATOR MANUAL FOR THE RIP-R-STRIPPER.**
- 3) OSHA RULES AND REGULATIONS RESEARCHED FOR AND/OR BY THE OWNER OF THE RIP-R-STRIPPER AND DEEMED APPLICABLE TO THE SAFE AND PROPER USE AND/OR OPERATION OF THE RIP-R-STRIPPER FOR ANY SPECIFIC JOB APPLICATION.**
- 4) LOCAL LAWS, REGULATIONS AND CUSTOMS RESEARCHED FOR AND/OR BY THE OWNER OF THE RIP-R-STRIPPER AND DEEMED APPLICABLE TO THE SAFE AND PROPER USE AND/OR OPERATION OF THE RIP-R-STRIPPER FOR ANY SPECIFIC JOB APPLICATION.**
- 5) FORMALIZED MAINTENANCE PROGRAM FOR THE RIP-R-STRIPPER TO BE DEvised BY THE OWNER OF THE RIP-R-STRIPPER IN ACCORDANCE WITH, BUT NOT NECESSARILY LIMITED TO, THE SPECIFICATIONS, GUIDELINES AND OPERATIONAL INFORMATION CONTAINED IN THE APPLICABLE OPERATOR MANUAL.**
- 6) COMPREHENSIVE OPERATIONAL INSTRUCTIONS FOR THE CORRECT AND PROPER USE OF THE RIP-R-STRIPPER AS PER THE CONTENTS OF THE APPLICABLE OPERATOR MANUAL.**

_____ Operator	_____ Owner/Instructor	_____ Date
_____ Operator	_____ Owner/Instructor	_____ Date
_____ Operator	_____ Owner/Instructor	_____ Date
_____ Operator	_____ Owner/Instructor	_____ Date
_____ Operator	_____ Owner/Instructor	_____ Date

Safety Precautions

DANGER

THE FOLLOWING SAFETY PRECAUTIONS PROVIDE SOME COMMON SENSE GUIDES TO PROMOTE SAFETY AND EFFICIENCY WITH THE RIP-R-STRIPPER. NO WARRANTY, GUARANTEE OR REPRESENTATION IS MADE BY THE MANUFACTURER AS TO THE ABSOLUTE CORRECTNESS OR SUFFICIENCY OF ANY INFORMATION OR STATEMENT. THESE SAFETY PRECAUTIONS ARE INTENDED TO DEAL PRINCIPALLY WITH COMMON PRACTICES AND CONDITIONS ENCOUNTERED IN THE USE OF THE RIP-R-STRIPPER AND ARE NOT INTENDED TO BE ALL INCLUSIVE. PROPER LEVELS OF OPERATOR EXPERIENCE, SKILL AND COMMON SENSE ARE ESSENTIAL FOR SAFE AND EFFICIENT OPERATION.

DANGER

THE DUSTS/BY PRODUCTS FROM THE COVERING REMOVAL PROCESS ASSOCIATED WITH THE OPERATION OF THE RIP-R-STRIPPER CAN CONTAIN CHEMICALS KNOWN TO THE STATE OF CALIFORNIA TO CAUSE CANCER, BIRTH DEFECTS OR OTHER REPRODUCTIVE HARM. THIS STATEMENT IS MADE IN COMPLIANCE TO CALIFORNIA PROPOSITION 65.

WARNING

INCORRECT USE OF THE RIP-R-STRIPPER CAN RESULT IN PROPERTY DAMAGE, PERSONAL INJURY OR EVEN DEATH. TO REDUCE THIS POSSIBILITY, GIVE COMPLETE AND UNDIVIDED ATTENTION TO THE JOB AT HAND AND FOLLOW THESE SAFETY PRECAUTIONS:

PREPARATION.

1) The RIP-R-STRIPPER is a specialized type of powered equipment, designed for a specific job function and requires adequate and thorough instruction BEFORE it is operated. The size, power, complexity and operating characteristics of this type of powered equipment would dictate that each operator must receive adequate, professional instruction regarding the proper operation of this RIP-R-STRIPPER before being allowed to utilize it. BEFORE

attempting to utilize this RIP-R-STRIPPER, read this Operator Manual, and any related material supplied by the manufacturer to familiarize each operator with its correct operating procedures. Avoid the urge not to take the necessary time to read this Operator Manual before operating the RIP-R-STRIPPER. DO NOT OPERATE THE RIP-R-STRIPPER UNTIL EACH OPERATOR COMPLETELY COMPREHENDS THE CONTENTS OF THIS MANUAL.

2) Develop a comprehensive program for the safe operation of the RIP-R-STRIPPER by its owner(s) and/or operator(s). Such a program will include, but is not limited to: instructional requirements for operation, applicable OSHA requirements, local laws and regulations, job site safety and a RIP-R-STRIPPER maintenance program. Constantly examine and upgrade this program to guarantee owner(s) and/or operator(s) safety. Each operator must be fully instructed regarding the specifics of this safety program.

3) Determine that the RIP-R-STRIPPER is in its original, factory configuration and has not been modified in any manner. Many modifications can result in potentially dangerous configurations that can lead to property damage and/or personal injury. If there are any questions about possible modifications made to the RIP-R-STRIPPER, contact the Customer Service Department for specific information BEFORE utilization. There is no charge for this service.

4) Minors should never be allowed to operate the RIP-R-STRIPPER. Bystanders, especially children and animals, should not be allowed in the area where the RIP-R-STRIPPER is in use. The covering removal process can result in flying particles being emitted at high velocity and striking the operator and/or onlookers. This can lead to the possibility of property damage and/or personal injury. Keep all body parts, loose clothing, foreign objects and onlookers clear of the blade or related attachments.

5) Operators must be in proper physical condition, mental health and not under the influence of any substance (drugs, alcohol, etc.) which might impair vision, dexterity or judgment. Working with the RIP-R-STRIPPER is strenuous. If you have any condition that might be aggravated by strenuous work, check with your doctor BEFORE operating the RIP-R-STRIPPER. Guard against the possibility of back related injuries. Always lift with leg muscles and not with the back. The RIP-R-STRIPPER requires that the operator be of proper height, weight and strength to maximize covering removal efficiency and minimize the possibility of personal injury.

6) Prolonged use of the RIP-R-STRIPPER (or other, similar machines) exposes the operator to vibrations which may produce Whitefinger Disease (Raynaud's Phenomenon). This phenomenon reduces the hand's ability to feel and regulate temperature, produces numbness and burning sensations and may cause nerve and circulation damage and tissue necrosis. Antivibration systems do not guarantee that you will not sustain Whitefinger Disease. Therefore, continuous and regular users should closely monitor the condition of their hands and fingers. After each period of use, exercise to restore normal blood circulation. If any of the symptoms appear, seek medical advice immediately.

7) Clothing must be sturdy and snug fitting, but allow complete freedom of movement. Never wear loose fitting jackets, scarves, neckties, jewelry, flared or cuffed pants or anything that could become caught on controls or moving parts. Wear long pants to protect your legs. Protect your hands with heavy duty, nonslip gloves to improve your grip. Good footing is most important when operating the RIP-R-STRIPPER. Wear sturdy boots with nonslip soles. Steel-toed safety shoes are highly recommended. Keep shoes properly laced. Never wear tennis shoes or other, similar type shoes which afford little or no protection. Wear an approved safety hard hat to protect the operator's head where there is a danger of head injuries.

8) Noise, generated by RIP-R-STRIPPER and the actual process itself, can damage your hearing. The RIP-R-STRIPPER operates with a noise emission greater than 70dBA. Hearing protection is required while operating or when near operating equipment. Continuous and regular operators should have their hearing checked regularly.

9) Flying debris, generated by the covering removal process, can cause eye injury. Eye protection is required while operating or when near operating equipment.

10) Visually inspect the RIP-R-STRIPPER and accessories for damaged or worn parts. Inspect each chisel or blade for sharpness and cracking. Look for loose and/or damaged handle grip areas. Check for loose and/or broken parts. Determine that operator controls work freely, all safety devices are operative and information/safety decals are readable. Check to determine that the RIP-R-STRIPPER and all related accessories are in good mechanical condition BEFORE utilization.

11) Contact appropriate representatives to determine if/where electrical cables, gas lines and other hazardous items are buried under the work surface

BEFORE utilization. The RIP-R-STRIPPER and related accessories are not classified as being insulated. Contact with buried electrical cables, gas lines and other hazardous items can result in electrocution and/or an explosion.

12) Know how the controls operate. Avoid accidental starting. Determine the ON/OFF switch is in the OFF position before plugging the power cord into the power source receptacle. Know how to stop the RIP-R-STRIPPER quickly in an emergency. Always start the RIP-R-STRIPPER according to the instructions as outlined in this manual to minimize the possibility of unexpected or uncontrolled accessory tool movement. Unexpected accessory tool movement can cause loss of machine control, and the possibility of property damage and/or personal injury.

13) Never exceed the recommended capacities of the RIP-R-STRIPPER. Refer to the **Specifications** section of this manual for more detailed information. Always utilize the correct chisels or blades designed for use with the RIP-R-STRIPPER. Use of an incorrect chisel or blade can result in property damage and/or personal injury.

14) Do not operate the RIP-R-STRIPPER on a job site location where potential reactive forces generated during the covering removal process can allow body parts to come in direct contact with a vertical wall, foundation or other support type structures in close proximity. Such an occurrence can result in property damage and/or personal injury. Always maintain a safe and reasonable distance from these types of structures.

OPERATION.

1) Give complete and undivided attention to the job at hand. Do not chew gum, smoke and/or use smokeless tobacco while utilizing the RIP-R-STRIPPER. Do not attempt to eat and/or drink while utilizing the RIP-R-STRIPPER. Determine that eyeglasses and/or hearing aid devices and other medical related devices are properly secured. Keep shoes properly laced. Use of the RIP-R-STRIPPER is strenuous and causes fatigue. Help prevent the cause of an accident. Plan to take work breaks as required to help maintain proper mental and physical alertness.

2) The RIP-R-STRIPPER is not sealed or insulated. Do not operate in an explosive atmosphere or near combustible materials. Refer to current OSHA rules and regulations.

3) The RIP-R-STRIPPER is designed for use by one operator. Use by more than one operator can lead to confusion and loss of control, resulting in damage and/or personal injury. Never operate the RIP-R-STRIPPER with an improper number of operators. Such a configuration can result in property damage and/or personal injury. If it is felt that a greater number of operators is required to furnish additional "down pressure" against the accessory tool, STOP and contact the Customer Service Department for specific operational and service/maintenance information. There is no charge for this service.

4) Do not operate the RIP-R-STRIPPER with onlookers close by. Caution all onlookers to stand clear. The covering removal process can result in flying particles being emitted at high velocity and striking the operator and/or onlookers. This can lead to the possibility of property damage and/or personal injury. Wear proper safety eyewear. Keep all body parts, loose clothing and foreign objects clear of the rotating auger.

5) Start the RIP-R-STRIPPER according to the instructions as outlined in this manual to minimize the possibility of unexpected accessory tool movement. Unexpected accessory tool movement can result in the loss of machine control and the possibility of property damage and/or personal injury. Do not utilize the RIP-R-STRIPPER if the ON/OFF switch is not operative. Replace the switch with a factory approved replacement part only. If you have any questions regarding proper starting procedures, contact the Customer Service Department BEFORE utilization. There is no charge for this service.

6) Operate the RIP-R-STRIPPER only when/where visibility and light are adequate for the job at hand. Work carefully. Always hold the operator handle firmly with both hands. Wrap your fingers around the handle grips/gripping areas, keeping the areas cradled between your thumbs and forefingers. Always determine the operator handle and grips/gripping areas are in good condition and free of moisture, pitch, oil or grease. Wear gloves to improve your grip. Never leave the RIP-R-STRIPPER running unattended.

7) Stop the RIP-R-STRIPPER when not in use. Turn the master ON/OFF switch to the OFF position. Allowing the RIP-R-STRIPPER to potentially operate substantially increases the potential for property damage and/or personal injury. Special care must be exercised in slippery conditions and on difficult, uneven

surfaces. Watch for cracks, high spots and other surface irregularities. Keep proper footing and balance at all times. The normal use of the RIP-R-STRIPPER is on level surfaces. Other terrains can be dangerous and should be avoided. Only properly trained operators should attempt these techniques.

8) Because the RIP-R-STRIPPER is classified as a low cost, low power, portable type machine, it is limited in the number of practical and/or suitable job applications for this type of equipment. A particular job site, application, job specifications and operator experience/skill/common sense may dictate that a different type of machine (with characteristics of higher purchase cost, being mounted to a carrier vehicle, with greater horsepower and less mobility), method and/or process be utilized to properly complete the job with the degree of efficiency and safety required. Contact the Customer Service Department for specific information regarding suitable job applications, job sites, and operator experience/skill/common sense recommendations for the RIP-R-STRIPPER BEFORE utilization. There is no charge for this service.

9) Do not expose the RIP-R-STRIPPER to rain or wet operating conditions. Water entering the tool can increase the risk of an electric shock.

10) Do not abuse the power cord. Never use the cord to move the RIP-R-STRIPPER or pull the plug from a receptacle. Damage to the cord and GFI can result. Keep the cord away from heat, oil, sharp edges (including the accessory tool) or moving parts. Replace a damaged cord with a factory approved replacement part only. A damaged cord increases the risk of an electric shock.

11) Do not operate the RIP-R-STRIPPER without a properly functioning GFI installed. Always assume the electrical wiring on every jobsite can contain a fault.

12) If operating the RIP-R-STRIPPER in an outside environment, use only extension cords marked "W-A" or "W". Such cords are rated for outside usage and reduce the risk of an electric shock.

13) Remove adjusting/tightening wrenches before starting the RIP-R-STRIPPER. A wrench that is left attached to a component can result in property damage and/or personal injury.

MAINTENANCE REPAIR AND STORAGE.

- 1) Use only genuine, approved replacement parts for maintenance and repair. Use of parts manufactured by others can result in property damage and/or personal injury.
- 2) Follow the **Service** instructions as outlined in the appropriate section of the Operator Manual.
- 3) Always stop and disconnect the cord from the power source BEFORE checking or working on the RIP-R-STRIPPER
- 4) Always properly maintain the RIP-R-STRIPPER. Frequently check all fastener and individual parts. Built in safety features are effective only if they are maintained in good working condition. Replace any questionable part or assembly with a genuine, approved replacement part. Do not forsake proper maintenance for the price of a few replacement parts. Proper maintenance does not cost---it actually pays dividends. Do not attempt any maintenance or repair work not described in the Operator Manual. Have such work performed at your dealer's servicing shop.
- 5) Determine the handle-mounted, electric motor ON/OFF switch is not damaged and allows for proper operation. Do not operate the RIP-R-STRIPPER with a damaged or worn, handle-mounted ON/OFF switch.
- 6) Maintain all safety and operation decals in proper condition. If any decal becomes damaged and/or unreadable, replace with a genuine, factory approved, replacement part only.
- 7) The RIP-R-STRIPPER may utilize locking type hexagon nuts to minimize the effects of vibration. Replace all self locking hardware with genuine, factory approved, replacement parts only.
- 8) At the conclusion of the useful service life of the RIP-R-STRIPPER, properly dispose of all components per local requirements. Wear appropriate safety apparel during the disassembly process. Recycle aluminum, steel and nonmetallic components properly per local requirements.

General Safety Information



Physical Exertion

Operating the RIP-R-STRIPPER requires proper physical stamina and mental alertness. Operators must be alert and of proper physical size and condition. Improper operation can result in physical injury and/or damage to the machine.



Noise

The RIP-R-STRIPPER operates with a noise emission level greater than 70dBA. Exposure to high noise emission levels can result in hearing loss or damage. Wear hearing protection when near or operating the RIP-R-STRIPPER.



Flying Debris

The covering removal process can result in flying debris. Contact with flying debris can result in personal injury. Wear eye protection and appropriate safety apparel when near or while operating the RIP-R-STRIPPER.



Explosion Hazard

The RIP-R-STRIPPER is not intended for use in hazardous locations. Operation can create sparks which may ignite gases, liquids or dusts. Do not operate in explosive atmospheres such as flammable gases, liquids or dusts.



Cut/Impact Danger

The accessory tool is not shielded while in use. Body contact with a stationary or moving accessory tool can result in personal injury. Do not come in contact with the accessory tool.



Body Strain

The covering removal process can result in body strain. Strain can inflict injury to lower back and upper body parts. Minimize the effects of strain with a combination of proper postures, common sense and regular work breaks.



Electrical Safety

The CTS12 RIP-R-STRIPPER utilizes a double insulated cord design. Never remove or modify the electrical plugs in any manner. Do not utilize adapter plugs. Consult a qualified electrician to determine if a power source is properly grounded. Do not operate without a proper GFCI.

Assembly

Open the shipping carton immediately upon receipt. Remove the RIP-R-STRIPPER from the carton. Visually inspect the contents for freight damage and/or missing parts. If shipping damage is evident, contact the delivering carrier immediately to arrange for an inspection of the damage by their claims representative. **DO NOT DESTROY OR DISCARD THE SHIPPING CARTON UNTIL INSTRUCTED BY AN AUTHORIZED REPRESENTATIVE OF THE CARRIER OR FACTORY.** Federal law requires that a claim be filed within a specified time period. If missing parts are detected, notify your dealer who will assist you in obtaining them.

Included in the shipment should be the following:

- 1 each, Model CTS12 RIP-R-STRIPPER
- 1 each, Mounting Kit for the Direct Mounting of a Specific Electric Breaker.
- 1 each, Final Inspection Form.
- 1 each, Tools for Success DVD

The CTS12 RIP-R-STRIPPER is shipped from the factory with the operator handle assembly installed in the main frame. All lubrication fittings are lubricated at the factory and will not require further servicing until the first scheduled maintenance. Visually inspect each component for signs of damage. If ordered with the RIP-R-STRIPPER, optional chisels, blades and accessories can be shipped separately or included in the shipping carton. If missing parts are detected, notify your dealer or the Customer Service Department who will assist you in obtaining them.

The RIP-R-STRIPPER is secured to the shipping pallet by means of an adjustable type strap. Carefully loosen the strap and remove the machine from the pallet.

INSTALLING THE MOUNTING KIT TO THE MAIN FRAME.

The installation of the mounting kit assembly will require a level working surface of sufficient size and appropriate height.

- 1) To place the operator handle in the work position, move the handle upright so that the ball-detent pins can be inserted through the operator handle and main frame. Determine the ball-detent pins are inserted

through the operator handle and main frame to fully expose the ball detent and properly lock in position. FIGURE 1.

WARNING

THE BALL DETENT MUST BE FULLY EXPOSED AGAINST THE MAIN FRAME TO PROVIDE THE PROPER PIN RETAINING FORCE. AN IMPROPER PIN RETAINING CONFIGURATION CAN RESULT IN UNEXPECTED OPERATOR HANDLE MOVEMENT. THIS OCCURRENCE CAN RESULT IN PROPERTY DAMAGE AND/OR PERSONAL INJURY.

- 2) Loosen the threaded handle knobs and extend the operator handle out until it stops against the threaded studs. Retighten the knobs. The handle height can be adjusted to compensate for a variance in operator height and job application requirements.

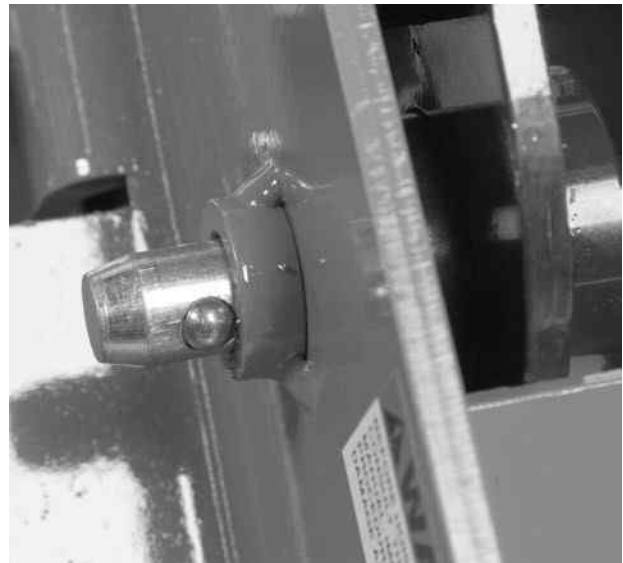

FIGURE 1

- 2) Deploy the kickstand legs in position to support the main frame on the work surface. This action will allow for easier installation of the accessory tool into the receiver chuck of the electric breaker. Proceed as follows:

- a) Rotate/position the over-center clamp to the rear of the main frame.
- b) Rotate the kickstand leg forward until it rests against

the main frame. The weight of the main frame is intended to help keep the kickstand leg in this position. FIGURE 2

c) Repeat the procedure for the other side.

d) To retract the kickstand leg, reverse the above procedure. Determine the over-center clamp positions correctly positions itself with the kickstand leg detent. This action will prevent the kickstand leg from random movement and resulting wear.



FIGURE 2

3) If so equipped, remove any attached carry handle from the breaker and properly store for potential use. Refer to the material supplied by the specific breaker manufacturer for additional information.

4) The RIP-R-STRIPPER incorporates two sets of blocks fabricated from a urethane material to collectively surround and compress against the electric breaker body when properly tightened. The urethane blocks are located and held in position within two (top and bottom) steel weldment assemblies. The bottom weldment assembly is designed to be directly fastened to the main frame. The top weldment assembly is designed to be secured to the bottom weldment by four (4) individual clamping screws. FIGURE 3.



FIGURE 3

5) For the installation of a typical electric breaker, one set of urethane mounting blocks will be located near the accessory tool chuck area (BOTTOM) while the other is located near the original location of the carry handle (TOP). The urethane mounting block set located toward the accessory tool chuck will characteristically feature a smaller insider diameter than that located near the carry handle location. Some electric breakers require the use of a separate sub frame to properly position it relative to the main frame. This configuration is depicted in FIGURE 4. Install the bottom welded mounting assembly to the main frame and secure tight with the supplied capscrews and lockwashers to 23 ft lbs (31 N.m). The main frame incorporates captive-type weld nuts. Do not overtorque. FIGURE 5.

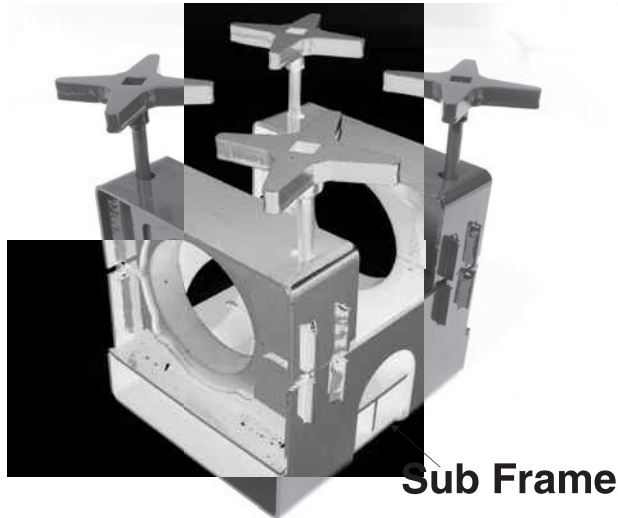

FIGURE 4

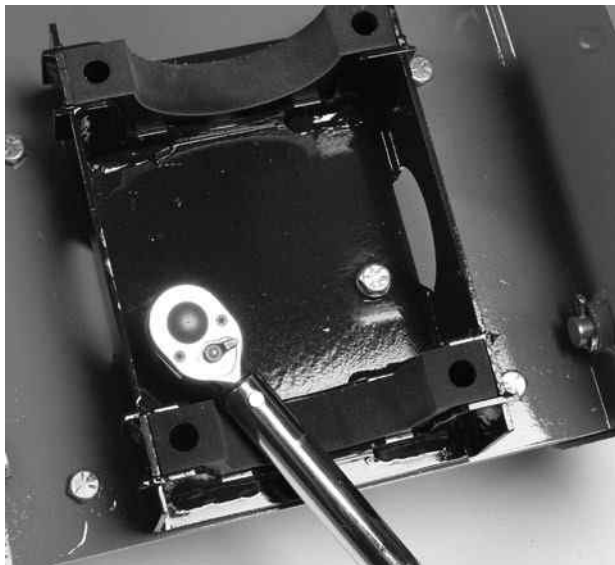

FIGURE 5

CAUTION

Do not over torque the mounting kit hardware. Improper torquing can result in property damage and/or personal injury.

WARNING

DO NOT SUBSTITUTE THE USE OF OTHER FASTENER CONFIGURATIONS TO SECURE THE MOUNTING FRAME WELDMENTS TO THE MAIN FRAME. OTHER CONFIGURATIONS CAN

INCREASE THE POTENTIAL FOR PROPERTY DAMAGE AND/OR PERSONAL INJURY.

INSTALLING THE ELECTRIC BREAKER TO THE MAIN FRAME.

1) Install the electric breaker into the cradle formed by the bottom urethane blocks and welded mounting assembly. Any breaker identification/logo design is normally intended to face the operator (TOP). Route the electric cable clear of the operator handle assembly. Any extension cord reinforcement provided for the electric breaker may come in contact with the main frame. As long as there is no relative movement during normal operation, this operating configuration is satisfactory. A typical installation is depicted in FIGURE 6.



FIGURE 6

a) The breaker receiver will normally be located adjacent to a urethane block. FIGURE 7.

b) Any recess in the breaker body casting for a carry handle is utilized to position and secure it to the urethane block. Variances to this procedure or installation may exist depending upon the specific breaker manufacturer and model. FIGURE 8 is for illustrative purposes only.

c) Determine the breaker is properly centered and positioned level against the main frame. A breaker that is not level relative to the work surface may not allow any specific accessory tool to properly function against

the work surface. An example would be the use of scraper blades to remove mastic or thinset materials. A breaker that is not mounted level with the work surface may not allow the blade edge to come in full contact, thereby not properly removing the material. It is important to note the orientation of the female hexagon shaped tool receiver can vary between manufacturer. A typical configuration is depicted in FIGURE 7.



FIGURE 7



FIGURE 8

WARNING

IMPROPERLY POSITIONING THE BREAKER IN THE BOTTOM WELDED MOUNTING ASSEMBLY AND MAIN FRAME CAN RESULT IN AN UNSTABLE PLATFORM CONFIGURATION. AN UNSTABLE PLATFORM CONFIGURATION CAN RESULT IN PROPERTY DAMAGE AND/OR PERSONAL INJURY.

2) Position and align the top welded mounting assembly. The upper urethane blocks must be aligned and centered against the lower urethane blocks. A typical installation is depicted in FIGURE 9.

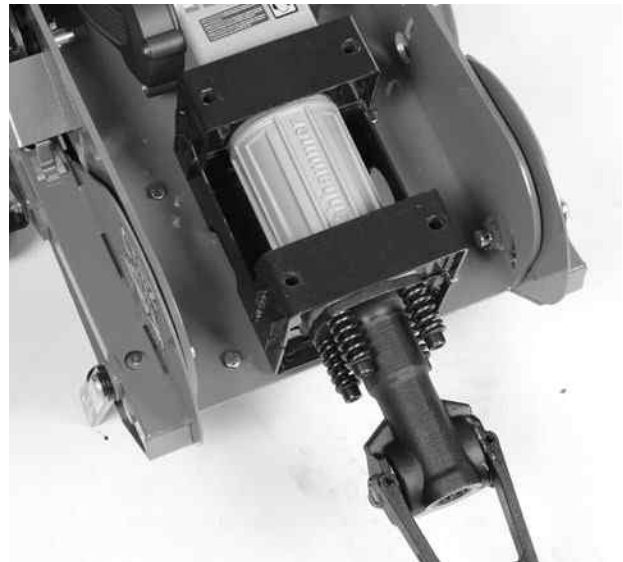

FIGURE 9

3) Position and align the mount cover to match the available slots and holes to the mounting configuration as required by the specific electric breaker. The mount cover, Part Number CTS12-0040, is designed to accommodate all approved electric breakers. Decal Part Number CTS12-5080 is applied to the bottom side of the mount cover. Refer to the decal markings for specific mounting information. FIGURE 10



FIGURE 10

4) Insert the four clamping screws into the appropriate mount cover slots/holes and into the urethane blocks until in contact with the threaded holes provided in the main frame. As a general rule, tighten each clamping screw in an “X” pattern until the top and bottom welded mounting assemblies come into direct contact. This process is intended to compress the urethane blocks against the breaker body and provide proper stability. FIGURE 11

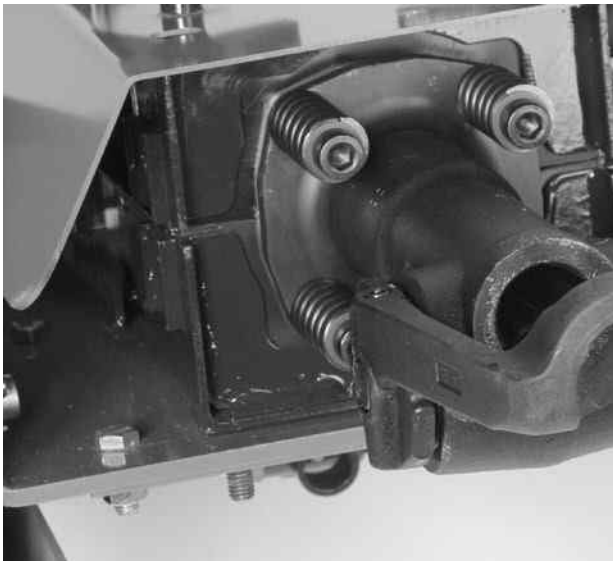

FIGURE 11

5) The urethane blocks have a memory characteristic that will allow them to partially return to their original configuration over time and allow multiple breaker installations and removals before they can no longer properly compress about the breaker body. When the urethane blocks can no longer properly compress about the breaker body, they should be replaced with factory approved replacement parts only.

CAUTION

Use of urethane blocks that have exceeded their useful service life and no longer can properly compress about the breaker body can result in property damage and/or personal injury.

6) Clamping screws can also be tightened to achieve the desired clamping forces with the use of a 1/2 inch drive ratchet or torque bar along with an appropriate length extension. FIGURE 12.



FIGURE 12

CAUTION

When utilizing a ratchet or drive system to tighten the clamping screws, do not apply excess torque. Excess torque can result in property damage and/or personal injury.

7) Wrap the excess electrical cord around the storage holders provided on the fixed section of the operator handle. Connect the breaker extension cord plug into the receptacle that connects to the internal ON/OFF switch located within the lower operator handle assembly. FIGURE 13.



FIGURE 13

8) Check to determine the adjustable length handle slides freely within the fixed section of the operator handle.

CAUTION

The ergonomic design considerations of the adjustable section of the operator handle will only function as intended if the handle grips are installed backwards (toward) the operator. Installing the adjustable section of the operator handle with the handle grips facing forward (away) from the operator will decrease machine control and productivity.

WARNING

INSTALLING THE ADJUSTABLE SECTION OF THE OPERATOR HANDLE WITH THE HANDLE GRIPS FACING FORWARD (AWAY) FROM THE OPERATOR WILL NOT ALLOW THE TREADED STUDS TO PROPERLY LOCATE WITHIN THE SLOTS PROVIDED IN THE ADJUSTABLE HANDLE. THE SLOT ENDS FORM INTEGRAL STOPS FOR THE

TREADED STUDS TO THRUST AGAINST. A PROPER STUD/SLOT CONFIGURATION WILL PREVENT THE ADJUSTABLE HANDLE FROM INADVERTENTLY SEPARATING FROM THE FIXED SECTION WHEN TRAVERSING DOWN AN INCLINE SUCH AS A STAIRWAY. INADVERTENT SEPARATION OF THE ADJUSTABLE SECTION CAN RESULT IN PROPERTY DAMAGE AND/OR PERSONAL INJURY.

WARNING

ALWAYS INSTALL AND OPERATE THE CTS12 RIP-R-STRIPPER WITH THE CONTROL ASSEMBLY LOCATED ON THE RIGHT SIDE AND THE HEIGHT ADJUSTMENT LEVER ON THE LEFT SIDE OF THE OPERATOR. IMPROPER CONFIGURATIONS CAN LEAD TO CONFUSION AND LOSS OF MACHINE CONTROL. SUCH A CONFIGURATION CAN RESULT IN PROPERTY DAMAGE AND/OR PERSONAL INJURY.

WARNING

IMPROPER KNOB TENSION AND/OR IMPROPERLY SECURING THE OPERATOR HANDLE TO THE MAIN FRAME CAN RESULT IN AN UNSTABLE PLATFORM CONFIGURATION. AN UNSTABLE PLATFORM CONFIGURATION CAN RESULT IN PROPERTY DAMAGE AND/OR PERSONAL INJURY.

WARNING

DETERMINE THAT ALL COMPONENTS OF THE RIP-R-STRIPPER ALLOW FOR PROPER FUNCTION. THE ON/OFF SWITCH THAT IS DEPLOYED BY THE CONTROL ASSEMBLY MUST PERFORM ITS PROPER FUNCTION AS STATED IN THIS MANUAL. IMPROPER COMPONENTS CAN RESULT IN PROPERTY DAMAGE AND/OR PERSONAL INJURY.

9) Check all fasteners for security. Consult a fastener torque chart for the proper torque value if any fastener is found to require retorquing.

10) Verify the control assembly that deploys the system ON/OFF switch returns to the OFF position when released with no binding. If binding is detected, remove the system switch access cover and determine potential causes. If the problem cannot be resolved, contact the Customer Service Department for assistance. There is no charge for this service.

11) Verify the extension system allows the electric breaker to be properly repositioned and locked into position. Determine the detent lock system prevents the extension lever from being accuated without the red safety latch lever from first being deployed. When the extension lever is deployed and released, a properly adjusted cable will allow the lever to return to the closed position without any exposed cable and the detent lock pin to be properly engaged. A bent, misaligned or damaged cable can prevent the extension system from properly securing the breaker in a specific position. If adjusting cable freeplay does not remedy the problem, consult the **Service** section of this manual for additional information or contact the Customer Service Department for assistance. There is no charge for this service.

Before Starting the RIP-R-STRIPPER

THEORY OF OPERATION

The CTS12 RIP-R-STRIPPER is designed to operate on the principle of an accessory tool operating with a direct impact (back and forth) action to remove a wide variety of covering materials from work surfaces. This action is provided by an electrically powered breaker in the 35 to 45 lbs category which is secured to the main frame by a specific mounting kit that is included with the machine. The accessory tool utilized will affect the type of materials to be removed, the material removal rate(s) and the resulting smoothness of the work surface.

The coverings removal process is directly controlled by these conditions:

1) The use of an accessory tool of proper design and configuration to impact and/or scrape against the work surface and remove material while delivering an acceptable service life.

2) Sufficient static weight or down force as provided by the operator supporting the accessory tool to allow it to effectively first penetrate and then remove the covering material.

3) Adequate force exerted against the RIP-R-STRIPPER by the operator to push the accessory tool against the covering material to deliver acceptable productivity rates.

4) Since no two covering materials are exactly alike, no two covering materials can be removed by the exact same method. The nature of the covering removal process, along with operator experience, skill and common sense, would suggest that efficient and productive material removal is a matter of trial and error. The accessory tool, along with the job site conditions and feed rates supplied by the operator, are direct factors that will directly determine the overall success of the job application.

ACCESSORY TOOL CONFIGURATIONS AND APPLICATIONS.

The CTS12 RIP-R-STRIPPER is designed to utilize electric breakers that normally incorporate the use of industry standard 1-1/8 inch hexagon x 6 inch shank accessory tools. These tools are manufactured by a number of manufacturers to industry design standards. For most job applications, the overall accessory tool length will vary between 18 and 22 inches, depending upon the specific tool design and usage. Accessory tools are forged from high carbon steel and heat treated to deliver a long service life. They will normally deliver very acceptable performance and service life when properly maintained. FIGURE 14.



FIGURE 14

WARNING

ALWAYS FOLLOW THE OPERATIONAL AND SAFETY INFORMATION AS PROVIDED BY THE SPECIFIC ACCESSORY TOOL MANUFACTURER. WEAR PROTECTIVE EYEWEAR, HEARING PROTECTION, FOOTWEAR AND HAND PROTECTION WHEN OPERATING THE RIP-R-STRIPPER. IMPROPER OPERATIONAL AND SAFETY PRECAUTIONS CAN RESULT IN PROPERTY DAMAGE AND/OR PERSONAL INJURY.

WARNING

DEPENDING UPON THE SPECIFIC TYPE, CONFIGURATION OR USAGE, THE ACCESSORY TOOL CAN BE EXTREMELY SHARP. IMPROPER HANDLING, INSTALLATION, REMOVAL OR TRANSPORTATION CAN RESULT IN PROPERTY DAMAGE AND/OR PERSONAL INJURY.

While individual accessory tool or blade design and configuration will vary, basic operational characteristics are identical: impact against a floor surface and remove the covering material. This common operational characteristic through extensive testing has led to the use of the following popular configurations:

Standard 1 and 3 Inch Wide Chisels

1) For most job applications involving the removal of ceramic tiles and glued-down type hardwood floors, the standard 1 and 3 inch wide chisels have proven to deliver acceptable productivity rates. Use of the two widths will be determined by how well the tile or flooring materials are actually bonded to the surface cap. Normal practice is to initially start the removal process by utilizing the 3 inch chisel and determine how effective the resulting blow force is at breaking loose and then removing the covering material from the surface cap. FIGURE 15.



FIGURE 15

2) If the 3 inch chisel is encountering difficulty in first loosening and then separating the covering material from the surface cap, the blow force being delivered by the breaker needs to be concentrated over a more narrow surface area. Remove the 3 inch chisel and install the 1 inch wide chisel. Repeat the evaluation process. Use of the 1 inch chisel will concentrate the blow force over a much more narrow area and should minimize difficulties in removing the tile. However, productivity rates for this operating configuration will normally be significantly reduced versus that of the 3 inch chisel. FIGURE 16.



FIGURE 16

3) The 3 inch chisel has also been demonstrated to be an effective tool for removing a wide range of thinset type materials from concrete surfaces. When utilized to remove thinset from sub floor materials, there is an increased risk of surface cap damage that will require repair before a new material can be installed.

Wide Flat Chisels

1) Flat chisels are available in usually 4 to 5 inch widths that are normally utilized with hand-held jackhammers for cutting asphalt and can also be adapted for removing thinset-type materials. Depending upon the adhesion strength to the floor surface, increased removal rates can sometimes be achieved over that of the 1 and 3 inch chisels. FIGURE 17.

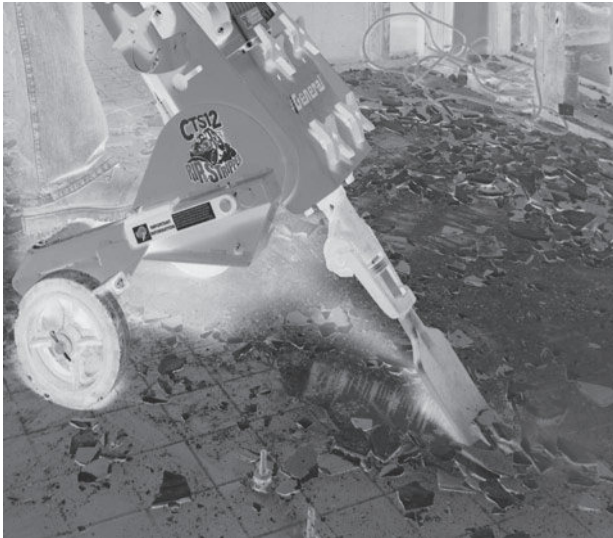

FIGURE 17

Scraper Blades

The CTS12 RIP-R-STRIPPER is designed for the use with scraper blade configurations up to 12 inches wide for a variety of job application, including: mastic and adhesive removal, thinset removal and general material build-up removal from concrete surfaces.

1) Scraper blades are manufactured from high carbon steel and heat treated for extended service life. They normally feature a blunt cutting edge configuration. The direct impact-type forces that are applied during the scraping/removal process are not usually compatible with the sharp, ground-type edges normally found with hand-operated scraper products. Hand-held type putty knives are a good example of the use of a blunt cutting edge.

2) Blades provided by General Equipment Company are available in 5, 8-1/2 and 12 inch widths. Use of a specific size is normally dependent upon such factors as: the type of material to be removed, thickness, adhesion strength and sub floor configuration.

3) Blades are intended to be utilized to remove mastics, adhesives, material build-ups, thinsets, etc from concrete type surfaces. Use of scraper blades on wood and certain sub floor configurations can result in excessive damage to the work surface because of the hammering effect of the blade edge. As a general rule of operation, scraper blades are not intended to be utilized on these types of surfaces.

4) As a general rule of operation, scraper blades will be utilized at higher angles relative to the work surface for most material and thinset removal job applications. Practical experience suggests the most effective blade angle range is 35 to 60 degrees relative to a flat surface. Positioning at a lower level prevents the blade edge from properly penetrating the surface material (mastics, adhesives, thinsets, etc.), thus allowing it to run or skim over rather than removing it. FIGURE 18.



FIGURE 18

CAUTION

Blades are provided with a protective finish from the heat treatment process. When not in use, protect and store the blade in an area free of environmental effects that can result in rust damage.

WARNING

WITH USAGE, BLADES CAN DEVELOP EXTREMELY SHARP EDGES. IMPROPER HANDLING WHILE INSTALLING/REMOVING FROM THE MACHINE OR WHILE IMPROPERLY TRANSPORTING CAN RESULT IN PROPERTY DAMAGE AND/OR PERSONAL INJURY.

WARNING

WHEN INSTALLING OR REMOVING A BLADE TO/FROM THE RIP-R-STRIPPER, ALWAYS WEAR THE APPROPRIATE SAFETY EYEWEAR, GLOVES, LEATHER SHOES AND LONG PANTS TO MAXIMIZE PERSONAL PROTECTION FROM THE SHARP EDGE(S). IMPROPER CONTACT WITH A SHARP EDGE CAN RESULT IN PROPERTY DAMAGE AND/OR PERSONAL INJURY.

INSTALLING AN ACCESSORY TOOL TO THE CTS12 RIP-R-STRIPPER.

Tool required: None, except as noted.

Because the CTS12 RIP-R-STRIPPER is designed to mount a wide variety of breaker models, no standard or specific procedure for mounting accessory tools can be developed. However, a general procedure covering basic installation is as follows:

- 1) Properly disconnect the extension cord or the RIP-R-STRIPPER from the power source. Turn the master ON/OFF switch to the OFF position.
- 2) Determine the adjustable section of the operator handle is properly attached to the main frame. Determine the ball-detent pins of the fixed section are properly installed. See **Assembly** section.

CAUTION

Improperly securing the adjustable section of the operator handle to the main frame can result in an unstable work platform configuration. An unstable platform configuration can result in property damage and/or personal injury.

- 3) On a level work surface, deploy the integral kick stands to raise the breaker receiver and allow the RIP-R-STRIPPER to properly lock itself into a stable position. To deploy the kick stand, raise the latching mechanism that positions/secures it to the frame. Raise the machine by depressing down on the operator handle. Rotate the kick stand until it comes in direct contact with the frame. Allow the machine weight to properly wedge the kick stand against the frame. Repeat for the other side. This configuration is referred to as the service position. FIGURE 19.



FIGURE 19

WARNING

EXERCISE EXTREME CAUTION WHEN WORKING NEAR OR UNDER THE RIP-R-STRIPPER WITH INTEGRAL KICK STANDS DEPLOYED IN THE SERVICE POSITION. IF THE RIP-R-STRIPPER IS NOT POSITIONED ON A STABLE WORK SURFACE OR POSITIONED IN A STABLE CONFIGURATION WITH THE KICK STANDS PROPERLY WEDGED BY

THE MACHINE WEIGHT, UNEXPECTED MOVEMENT CAN ALLOW THE RIP-R-STRIPPER TO FALL FORWARD OR BACKWARDS RELATIVE TO THE WORK SURFACE. THIS OCCURRENCE CAN RESULT IN PROPERTY DAMAGE AND/OR PERSONAL INJURY

4) Inspect the breaker accessory tool for a visual indication of deformation and/or cracking. If such damage is noted, discard the accessory tool for a suitable replacement.

WARNING

USE OF A WORN AND/OR DAMAGED ACCESSORY TOOL CAN RESULT IN PROPERTY DAMAGE AND/OR PERSONAL INJURY. CONSULT THE ACCESSORY TOOL MANUFACTURER FOR SPECIFIC INFORMATION.

5) Align and install the male shank of the accessory tool into the full length the breaker receiver. FIGURE 20 is for illustrative purposes only.

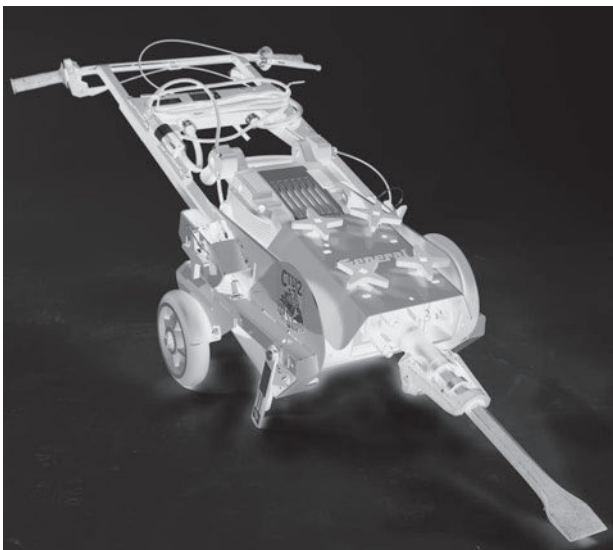

FIGURE 20

6) Deploy the specific accessory tool locking device to properly retain the accessory tool in the receiver. Deployment methods or procedures may differ between manufacturers and breaker models. Consult the breaker manufacturer for specific information. FIGURE 21 is for illustrative purposes only.



FIGURE 21

7) Retract the integral kick stands to allow the accessory tool to be in full contact with the level work surface. Properly secure the kick stands to the frame with the latching mechanisms. NOTE: for proper action, the entire width of the accessory tool cutting edge must be in direct contact with the work surface.

8) If the entire width of the accessory tool cutting edge is not in direct contact with the work surface, the breaker will require repositioning within the mounting kit to realign it in relationship to the work surface. Consult the **Assembly** section.

9) The integral kick stands can be deployed as necessary to locate the RIP-R-STRIPPER and accessory tool in a position above the work surface. This configuration can be utilized to install or remove accessory tools or for performing required service/maintenance to the breaker or RIP-R-STRIPPER. FIGURE 22.



FIGURE 22

10) An installed accessory tool equipped with a scraping blade configuration can include a sharp cutting edge. Contact with the sharp edge can result in property damage and/or personal injury.

WARNING

ACCESSORY TOOLS CAN BE EXTREMELY SHARP. CONTACT WITH THE TOOL EDGE CAN RESULT IN PROPERTY DAMAGE AND/OR PERSONAL INJURY. PROPERLY STORE AND HANDLE A SHARP TOOL TO MINIMIZE THE POTENTIAL FOR PROPERTY DAMAGE AND/OR PERSONAL INJURY.

11) Determine the breaker ON/OFF switch is in the OFF position. If the RIP-R-STRIPPER is to be used immediately, then reconnect the breaker power cord to the internal switch receptacle. FIGURE 23 is for illustrative purposes only.



FIGURE 23

WARNING

UNEXPECTED MACHINE START-UP CAN RESULT IN PROPERTY DAMAGE AND/OR PERSONAL INJURY.

12) If the RIP-R-STRIPPER is to be used immediately, then connect the extension cord to the machine and power source. The extension cord utilizes a twist-lock type connection to the machine and a standard NEMA 5-15P plug with an integral GFI. The GFI configuration can vary from specific manufacturer

DANGER

DO NOT OPERATE THE RIP-R-STRIPPER WITHOUT THE EXTENSION CORD, TWIST-LOCK CONNECTION DEVICE AND GFI IN PROPER OPERATING CONDITION. THE GFI IS INTENDED TO ACT AS A SAFETY DEVICE IN THE EVENT THE POWER SOURCE HAS A FAULT. A FAULT CAN CREATE A DANGEROUS OPERATING CONFIGURATION THAT CAN RESULT IN PROPERTY DAMAGE AND/OR PERSONAL INJURY.

DANGER

DO NOT MODIFY OR REPLACE ANY EXTENSION CORD COMPONENT WITHOUT UTILIZING A FACTORY APPROVED COMPONENT ONLY.

13) To remove the accessory tool from the RIP-R-STRIPPER, repeat the installation process in reverse order.

Operation

OPERATIONAL DISCLAIMER.

THE MANUFACTURER OF THE RIP-R-STRIPPER MAKES NO WARRANTY OR GUARANTEE THAT IT IS MERCHANTABLE AND/OR SUITABLE FOR ANY SPECIFIC JOB APPLICATION AND THAT IT WILL HAVE THE POWER REQUIRED TO REMOVE ANY SPECIFIC COVERING FROM ANY SPECIFIC WORK SURFACE.

CALIFORNIA PROPOSITION 65 DISCLAIMER.

DANGER

THE DUST/BY-PRODUCTS FROM THE COVERING REMOVAL PROCESS ASSOCIATED WITH THE OPERATION OF THE RIP-R-STRIPPER CAN CONTAIN CHEMICALS KNOWN TO THE STATE OF CALIFORNIA TO CAUSE CANCER, BIRTH DEFECTS, OR OTHER REPRODUCTIVE HARM.

INFORMATION RELATIVE TO MINIMUM COMPONENT STANDARDS FOR THE OPERATION OF THE CTS12 RIP-R-STRIPPER.

For operational, safety and overall productivity considerations, it is required that specific RIP-R-STRIPPER components meet minimum acceptable operational standards as follows:

1) Operator handle be properly mounted to the main frame and be of proper structural integrity. If cracking, deformation or worn components are detected, replace the operator handle or related components with a factory approved replacement part only.

2) The operator handle is equipped with properly fitting and adhered handle grip area of sufficient integrity to allow for proper job function as outlined in this manual. A loose fitting or torn handle grip material is not permitted.

3) A master ON/OFF switch that allows it to perform its intended job function as outlined in this manual. Replace the master ON/OFF switch with a factory approved replacement part only.

4) A power cord, connecting devices and/or extension cord of proper structural integrity that meet all applicable National Electric Code requirements.

5) Urethane blocks which allow proper retention of the electric breaker and perform their intended job function as outlined in this manual. Inspect the urethane blocks before each use. Do not operate the RIP-R-STRIPPER without the correct number of blocks. Do not operate the RIP-R-STRIPPER with a damaged and/or improperly secured block. Replace any worn and/or damaged block with a factory approved replacement part only.

6) An accessory tool of proper structural integrity (void of cracks, etc), straightness, sharpness, etc., which is properly retained by the electric breaker. Replace a worn and/or damaged accessory tool with a factory approved replacement only.

7) An accessory tool receiver of proper structural integrity that allows accessory tools to be properly retained. Replace a worn and/or damaged accessory tool receiver with a factory approved replacement only.

8) Accessory tool fasteners that are of the original, factory type design. The use of non factory approved replacement components is not allowed.

8) Extension lever system is of proper structural integrity and proper adjustment to allow it to perform its intended job function as outlined in this manual. Adjust any component as necessary. Replace any worn and/or damaged component with a factory approved replacement part only.

9) All safety decals, Operator Manual and operational information decals (including the applicable Quik-Tips information) must be in proper and readable condition. Replace any missing and/or damaged safety decal, Operator Manual and/or information decal with a factory approved replacement part only.

WARNING

OPERATION OF THE RIP-R-STRIPPER UTILIZING COMPONENTS NOT MEETING MINIMUM OPERATIONAL STANDARDS CAN RESULT IN PROPERTY DAMAGE AND/OR PERSONAL INJURY.

GENERAL TRANSPORTATION INFORMATION.

When transporting the RIP-R-STRIPPER in/on a motor vehicle, properly secure with suitable strapping or tie downs. Personnel should not be transported in the same compartment as equipment and fuel supplies. Consult applicable OSHA regulations for specific information.

CAUTION

An improperly secured RIP-R-STRIPPER and related accessories can fall from a moving vehicle and result in property damage and/or personal injury.

CAUTION

Do not drop the RIP-R-STRIPPER directly against the tool receiver and/or wheels. Direct impact against the tool receiver and/or wheels can result in damage to components, including the electric breaker, main frame, urethane blocks, etc.

1) When transporting the RIP-R-STRIPPER, remove the accessory tool from the electric breaker when in the following operating configurations:

- a) To and from the jobsite.
- b) For longer distances while being repositioned on the jobsite.
- c) When traversing up and down stairways.
- d) While performing maintenance and/or repairs.

Remove the accessory tool according to the procedures as outlined in this manual for the above listed operating configurations.

2) To reduce the storage area required to transport the RIP-R-STRIPPER in a suitable vehicle, the operator handle can be folded relative to the main frame. Follow the instructions as outline in this manual. See **Assembly** section.

a) Remove the accessory tool and properly store while transporting.

b) Do not allow the operator handle and main frame to come in direct contact with each other while transporting. Provide proper and adequate protection between RIP-R-STRIPPER components and vehicle interior, including seats, upholstery, etc. Such an occurrence can result in property damage.

c) Properly secure the RIP-R-STRIPPER within the vehicle interior while transporting to minimize the potential for property damage and/or personal injury in the event of a sudden stop or accident. Transport the RIP-R-STRIPPER according to prevailing and applicable rules and regulations.

WARNING

TRANSPORTING THE RIP-R-STRIPPER WITH THE ACCESSORY TOOL INSTALLED AND/OR IMPROPERLY SECURED CAN RESULT IN PROPERTY DAMAGE AND/OR PERSONAL INJURY.

STARTING THE CTS12 RIP-R-STRIPPER ON THE JOBSITE.

1) Position the RIP-R-STRIPPER on a suitable work surface.

2) Install the accessory tool according to the procedures as outlined in this manual.

3) Determine the electric breaker ON/OFF switch is in the OFF position. FIGURE 24 is for illustrative purposes only.



FIGURE 24

4) Determine the master ON/OFF switch is in the OFF position. FIGURE 25.



FIGURE 25



DANGER

UNEXPECTED MACHINE START-UP CAN RESULT IN PROPERTY DAMAGE AND/OR PERSONAL INJURY.

5) The CTS12 RIP-R-STRIPPER is designed to operate from a clean, 15 ampere, 115 VAC, 60 Hz, nominal power source. Contact the Customer Service Department for information relative for operation from a 220 VAC, 50 Hz power source. A clean power source refers to the amperage available from the individual electrical circuit selected. Additional electrical products already utilizing the same circuit will reduce the available amperage, resulting in starting and operational difficulties.



CAUTION

Operating the CTS12 RIP-R-STRIPPER from a power source of improper voltage and/or amperage will result in unreparable damage to the electric breaker and related controls.

6) Providing proper voltage and amperage levels to the breaker motor is essential to obtain maximum productivity and service life. Low voltage and amperage levels will cause the breaker to overheat. Many electric breakers do NOT incorporate a winding temperature monitor system that warns of a possible overload when the motor winding approach harmful temperature levels. High temperatures can damage internal components.

7) If the specific job application requires the use of additional extension cord length, determine each cord is of proper structural integrity and size (AWG) to meet applicable National Electric Code and OSHA requirements. An additional extension cord can be utilized in conjunction with an external GFI. Plug the extension cord into a portable GFI device. Plug the portable GFI device into the power source receptacle. Connect the cord to the provided extension cord/GFI. This configuration will allow any fault over the length of a defective extension cord to be indicated.



WARNING

BEFORE USE, INSPECT EACH EXTENSION CORD AND WIRING DEVICE FOR PROPER STRUCTURAL INTEGRITY. DO NOT UTILIZE A CORD WITH A WORN OR CUT OUTER JACKET MATERIAL. DO NOT UTILIZE A CORD WITH EXPOSED INNER WIRES OR INSULATION MATERIAL. DO NOT UTILIZE A CORD THAT HAS BEEN REPAIRED WITH ELECTRICAL TAPE. USE OF A CORD WITH IMPROPER STRUCTURAL INTEGRITY CAN

RESULT IN PROPERTY DAMAGE AND/OR PERSONAL INJURY.

WARNING

FOR MAXIMUM PROTECTION AGAINST A FAULT, ALWAYS CONFIGURE A GROUND FAULT CIRCUIT INTERRUPTER TO BE PLUGGED INTO THE POWER SOURCE RECEPTACLE. A CONFIGURATION WITH THE GROUND FAULT CIRCUIT INTERRUPTER PLACED BETWEEN THE RIP-R-STRIPPER AND THE POWER SOURCE WILL NOT AFFORD MAXIMUM PROTECTION AGAINST A POTENTIAL FAULT.

WARNING

ALL ELECTRICAL WIRING INCLUDING EXTENSION CORD GAUGE SIZE AND/OR LENGTH MUST BE INSTALLED AND/OR APPROVED IN ACCORDANCE WITH LOCAL ELECTRICAL CODES AND PRACTICES. AN IMPROPER WIRING INSTALLATION CAN RESULT IN PROPERTY DAMAGE AND/OR PERSONAL INJURY.

8) Determine the power source receptacle to be utilized is properly grounded. This can be accomplished with proper testing equipment and procedures. If there are any questions regarding the suitability of specific power receptacle, contact your dealer or the Customer Service Department for assistance BEFORE utilizing the RIP-R-STRIPPER. There is no charge for this service. A qualified electrician may need to be consulted and properly compensated.

9) Position the electric breaker in a vertically orientated position (approximately 45 degrees) or as desired for operation following this procedure:

a) Using the left forefinger, depress and hold the red safety latch lever. FIGURE 26.



FIGURE 26

CAUTION

A properly adjusted and maintained red safety latch lever prevents the extension system lever to be inadvertently depressed. Such an occurrence can allow unexpected movement of the electric breaker in a downward direction. Failure to properly depress the red latch system lever BEFORE depressing the latch lever can result in damage to the lever and cable system. Such occurrence can also result in property damage and/or personal injury.

b) At the same time, while also using the left hand, pull/depress the extension system lever to release the locked detent pin. FIGURE 27.



FIGURE 27

c) The gas shock system will assist to raise or lower the electric breaker to the desired position. Release/position the extension system lever to allow the detent pin to properly seat itself when the extension system lever is released. Nine positions are provided.

d) Release the red safety latch lever and the extension system lever simultaneously to allow the detent pin to properly lock in position.

WARNING

THE EXTENSION SYSTEM DOES NOT PROVIDE FOR AN INFINITE NUMBER OF LOCKING POSITIONS FOR USE ON THE JOBSITE. NINE POSITIONS ARE PROVIDED. DETERMINE THE DETENT PIN IS IN THE CORRECT POSITION AND PROPERLY LOCKED BEFORE ATTEMPTING TO OPERATE AND/OR MOVE THE RIP-R-STRIPPER. AN IMPROPERLY LOCKED DETENT PIN CAN ALLOW THE OPERATOR HANDLE TO MOVE UNEXPECTEDLY. SUCH AN OCCURRENCE CAN RESULT IN PROPERTY DAMAGE AND/OR PERSONAL INJURY.

10) Position the tip/end of the accessory tool on the work surface in a direction facing away from the body.

11) Turn the electric breaker ON/OFF switch to the ON/locked position. Consult the materials supplied by the specific breaker manufacturer for additional

information. Follow all procedures as outlined.

12) Turn the master ON/OFF switch to the ON position. Determine the system circuit breaker is in the operate position. If the circuit breaker is deployed, STOP and turn the electric breaker ON/OFF switch to the OFF position. Investigate the cause of the problem. Contact the Customer Service Department for assistance BEFORE further utilization. There is no charge for this service. FIGURE 28.



FIGURE 28

13) Push forward on the operator handle to allow the top of the accessory tool to come in contact with the internal anvil of the electric breaker. If the accessory tool does not properly contact the anvil, the blow force from the breaker will not be transmitted. The electric breaker will function, but no work will be accomplished.

14) Using your left hand, firmly grasp the operator handle grip. With your right hand, rotate the control assembly to start the electric breaker. Rotation of the control activates an internal switch located in the lower operator handle. The system is designed to immediately STOP the electric breaker when released. The internal ON/OFF switch allows the operator to STOP the electric breaker when the RIP-R-STRIPPER is not in operation. This feature prevents dry fire conditions that can damage breaker components and significantly decrease operator control. FIGURE 29.



FIGURE 29

CAUTION

If the electric breaker does not immediately STOP when the control assembly is released, STOP the RIP-R-STRIPPER by turning the master ON/OFF switch to the OFF position. Determine the cause and properly repair and/or adjust the internal ON/OFF switch or connecting cable system. Operation with an improperly functioning internal ON/OFF switch can result in property damage and/or personal injury.

WARNING

DO NOT OPERATE THE RIP-R-STRIPPER IF THE ELECTRIC BREAKER DOES NOT STOP WHEN THE CONTROL ASSEMBLY IS RELEASED. OPERATION WITH AN IMPROPERLY FUNCTIONING INTERNAL ON/OFF SWITCH CAN RESULT IN PROPERTY DAMAGE AND/OR PERSONAL INJURY.

WARNING

AS SOON AS THE ELECTRIC BREAKER HAS STARTED, THE OPERATOR MUST BE IN A POSITION TO ASSUME DIRECT AND FULL CONTROL OF THE RIP-R-STRIPPER. FAILURE TO ASSUME DIRECT AND FULL CONTROL CAN RESULT IN PROPERTY DAMAGE AND/OR PERSONAL INJURY.

15) Stopping the CTS12 RIP-R-STRIPPER is accomplished by releasing the control assembly to allow the internal ON/OFF switch to deploy to the OFF position. As a backup system, the master ON/OFF switch can also be turned to the OFF position to stop the machine. For safety considerations, turn the master ON/OFF switch to the OFF position when not in use. FIGURE 30.



FIGURE 30

DANGER

DO NOT MODIFY, BYPASS OR DISABLE THE INTERNAL ON/OFF SWITCH TO PREVENT IT FROM STOPPING THE ELECTRIC BREAKER. SUCH A CONFIGURATION WILL NOT ALLOW THE OPERATOR TO STOP THE RIP-R-STRIPPER QUICKLY IN THE EVENT OF AN EMERGENCY.

CAUTION

If the RIP-R-STRIPPER and/or an individual component/accessory tool does not appear to be functioning properly, STOP and do not operate further until the corrective action has been completed. If there are any questions regarding the proper operation of the RIP-R-STRIPPER, contact the Customer Service Department for assistance BEFORE further utilization. There is no charge for this service.

OPERATING THE CTS12 RIP-R-STRIPPER ON THE JOB SITE.

WARNING

THE FLOOR COVERINGS REMOVAL PROCESS CAN PRODUCE EXCESSIVE NOISE, VIBRATION AND FLYING DEBRIS. ALL OPERATORS AND WORK PERSONNEL IN THE VICINITY OF THE RIP-R-STRIPPER MUST WEAR APPROPRIATE SAFETY EYE WEAR AND HEARING PROTECTION DEVICES. OTHER SAFETY APPAREL AND/OR PROCEDURES, DEEMED NECESSARY BY SUPERVISORY PERSONNEL, MUST ALSO BE WORN AND/OR PRACTICED BY ALL APPROPRIATE PERSONNEL.

1) The RIP-R-STRIPPER utilizes direct blow force from the electric breaker to impact the accessory tool against the work surface. This design configuration substantially enhances machine control and reduces fatigue as long as the accessory tool does not come in direct contact with a larger, protruding obstruction (anchor bolt, nail head, material variances, etc) from the floor. Direct contact with such an obstruction can result in rapid and jerky directional movement of the machine.

CAUTION

Exercise extreme caution when operating the RIP-R-STRIPPER in the vicinity of anchor bolts, pipes, columns, openings, large cracks, utility outlets or any object protruding from the work surface. Contact with such objects can lead to loss of machine control, resulting in property damage and/or personal injury.

DANGER

ALWAYS MAINTAIN PROPER CONTROL OF THE RIP-R-STRIPPER. IF AN OPERATOR LOOSES CONTROL, A "RUNAWAY" MACHINE CAN RESULT IN PROPERTY DAMAGE AND/OR PERSONAL INJURY. BEFORE OPERATION ON THE JOBSITE, DETERMINE THAT RELEASING THE CONTROL HANDLE PROPERLY STOPS THE ELECTRIC BREAKER.

WARNING

WHEN OPERATING THE RIP-R-STRIPPER ON ABOVE GROUND FLOOR LEVELS, EXERCISE EXTREME CAUTION TO PREVENT LOSS OF CONTROL THAT COULD ALLOW THE MACHINE AND/OR OPERATOR TO FALL DOWN TO LOWER LEVELS. WHEN MOVING BACKWARDS DURING THE COVERING MATERIAL REMOVAL PROCESS, BE AWARE OF POTENTIAL DROP-OFFS AND OBSTRUCTIONS ON THE JOBSITE.

2) Proper operator posture and stance will enhance productivity rates and minimize fatigue. Keep the upper body as vertical as possible. Keep legs at a comfortable distance apart to maximize leverage and locomotion force. A proper operator position is depicted in FIGURE 31. Improper operator positions are depicted in FIGURES 32 and 33. The proper and improper operation positions depicted in this manual are not all inclusive.

3) The wide variety of potential covering materials along with the corresponding variety of jobsite environments, makes it impossible to develop standardized operating procedures for the RIP-R-STRIPPER. Use of the RIP-R-STRIPPER will require constant trial and error until satisfactory results are achieved. Experience, gained over time, along with good common sense, will help minimize the amount of necessary testing. Many factors will directly affect the operating parameters and/or techniques utilized for a specialized job application. Some of these factors include:

a) Work surface material yield and tensile values, as a general rule, will determine material removal rates per

unit of time. Materials with high yield and tensile values will lower accessory tool penetration. For such materials, the accepted procedure is to decrease the effective tool/blade width and determine the optimum tool/blade angle relative to the work surface. This will require adjusting the tool/blade angle with the extension system.



FIGURE 31



FIGURE 32

b) Higher material removal rates can sometimes be achieved by making a series of passes 90 degrees to each other to form a waffle-like pattern. This technique is especially useful when removing deeper accumulations of rubber-like materials, material

residues and dirt/debris from industrial floors.

c) The covering material removal process can be extremely abrasive to the accessory tool cutting edge. Straight edge type blades are not intended to be resharpened. Depending upon the exact configuration, blades maybe sharpened in the field by the use of a metal file or other accepted process. The use of the file or other sharpening process will not duplicate the original blade sharpening process, but can significantly increase overall productivity rates versus continued use of a dull blade. Remove the blade from the RIP-R-STRIPPER per the procedures outlined in this manual. Sharpen according to industry accepted practices and procedures.



FIGURE 33

WARNING

EXERCISE EXTREME CAUTION WHEN SHARPENING A BLADE. PROPERLY SECURE THE BLADE DURING THE SHARPENING PROCESS. REMAIN CLEAR OF THE CUTTING EDGE DURING THE SHARPENING PROCESS. OBSERVE ALL SAFETY INSTRUCTIONS. IMPROPER CONTACT WITH THE BLADE CAN RESULT IN PROPERTY DAMAGE AND/OR PERSONAL INJURY.

4) The floor covering material removal process on many work materials can produce sparks, dusts and other foreign particle contamination. Many covering materials, adhesives or mastics can contain asbestos and other chemicals that are known to cause physical harm and/or affect the environment. These types of

materials need to be properly identified, contained and disposed of according to established OSHA, EPA and other rules and regulations.

WARNING

SPARKS PRODUCED BY THE ACTION OF THE ACCESSORY TOOL CUTTING BLADE AGAINST THE WORK SURFACE (FOR EXAMPLE: STRIKING ANCHOR BOLTS) CAN RESULT IN A FIRE AND/OR EXPLOSION DEPENDING UPON EXISTING ENVIRONMENTAL CONDITIONS. THIS OCCURRENCE CAN RESULT IN PROPERTY DAMAGE AND/OR PERSONAL INJURY.

WARNING

THE CREATION OF DUST AND OTHER FOREIGN PARTICLE CONTAMINATION FROM THE COVERING MATERIAL REMOVAL PROCESS CAN RESULT IN PROPERTY DAMAGE AND/OR PERSONAL INJURY. FOR SUCH OPERATING CONDITIONS, ALWAYS WEAR A NIOSH/MSHA APPROVED DUST/MIST RESPIRATOR AND APPROPRIATE SAFETY RELATED APPAREL. CONSULT APPLICABLE OSHA REGULATIONS FOR SPECIFIC INFORMATION.

5) Dust and other particle contamination can be controlled by the use of an appropriate industrial-type water mist spray system to remove/control dust and other particle contamination from the work surface.

WARNING

ALWAYS UTILIZE A WATER MIST SPRAY SYSTEM TO OPERATE WITHIN THE SPECIFIC JOB SITE REQUIREMENT. DUST MATERIALS CAN MEET CLASS II OR CLASS III SPECIFICATIONS AS DEFINED BY THE NATIONAL ELECTRIC CODE REGULATIONS FOR HAZARDOUS MATERIALS. CONSIDERATION MUST ALSO BE GIVEN TO THE CREATION OF HAZARDOUS-TYPE MATERIALS REQUIRING SPECIFIC DISPOSAL PROCEDURES. DETERMINE THE WATER MIST SPRAY SYSTEM IS PROPERLY DESIGNED TO OPERATE WITHIN THESE ATMOSPHERES. CONSULT CURRENT NATIONAL ELECTRIC CODE, OSHA AND EPA REGULATIONS FOR SPECIFIC INFORMATION.

6) Excessive water applied to the work surface is normally not utilized to control dust and other particle contamination. Excessive water, and/or other conductive materials, should be removed from the work surface by an industry-approved and/or accepted practice BEFORE utilizing the RIP-R-STRIPPER to remove the covering material. The presence of water and/or any other conductive material on the work surface can substantially increase the potential electrocution concern for the operator and/or associated work personnel.

WARNING

WATER OR OTHER CONDUCTIVE MATERIALS DEPOSITED ON THE WORK SURFACE INCREASES THE ELECTROCUTION HAZARD POTENTIAL FOR THE OPERATOR AND/OR ASSOCIATED WORK PERSONNEL. DETERMINE THE RIP-R-STRIPPER IS PROPERLY GROUNDED (NO FAULTS), POWER CORDS ARE FREE OF CUTS, ABRASIONS AND EXPOSED CABLE STRANDS. IMPROPER GROUNDING AND THE USE OF DAMAGED POWER CORDS CAN RESULT IN PROPERTY DAMAGE AND/OR PERSONAL INJURY.

7) Normal use of the RIP-R-STRIPPER will allow the build-up and accumulation of materials on exposed surfaces. It is highly recommended that all exposed surfaces be properly cleaned after each use. Adjust the wheel scraper clearance to minimize material accumulations.

CAUTION

Failure to properly clean the RIP-R-STRIPPER can result in the formation of dried material build-ups and accumulations. This occurrence can reduce bearing service life and increase the vibration levels felt by the operator during use.

WARNING

WHEN CLEANING THE RIP-R-STRIPPER USE ONLY A SAFETY-TYPE SOLVENT THAT WILL NOT DETERIORATE AND REDUCE THE SERVICE LIFE OF THE ELASTOMERIC RUBBER AND URETHANE MOUNTS.

WARNING

PROPERLY DISPOSE OF ALL ACCUMULATED COVERING MATERIALS PER OSHA AND EPA CODES AND REGULATIONS. MANY MATERIALS CAN BE CLASSIFIED AS HAZARDOUS AND REQUIRE PROPER DISPOSAL PROCEDURES. CONTACT THE APPLICABLE GOVERNMENT AGENCIES FOR SPECIFIC INFORMATION.

8) When the covering removal process creates a considerable amount of loose material on the work surface, it can be almost impossible to determine proper material removal depths and the extent of the work already completed. The problem can be further compounded if a proper vacuum system and/or broom is not utilized. Loose material should be consistently removed with an appropriate vacuum or broom during the removal process.

STOPPING THE CTS12 RIP-R-STRIPPER ON THE JOBSITE.

Stop the RIP-R-STRIPPER by releasing the control handle to move the internal ON/OFF switch located within the operator handle to the OFF position. As a backup system, the master ON/OFF switch can be turned to the OFF position to stop the RIP-R-STRIPPER. As a safety precaution, turn the master ON/OFF switch located on the operator handle to the OFF position when the machine is not in use. As an added safety measure, disconnect the GFI from the power source. FIGURE 34.

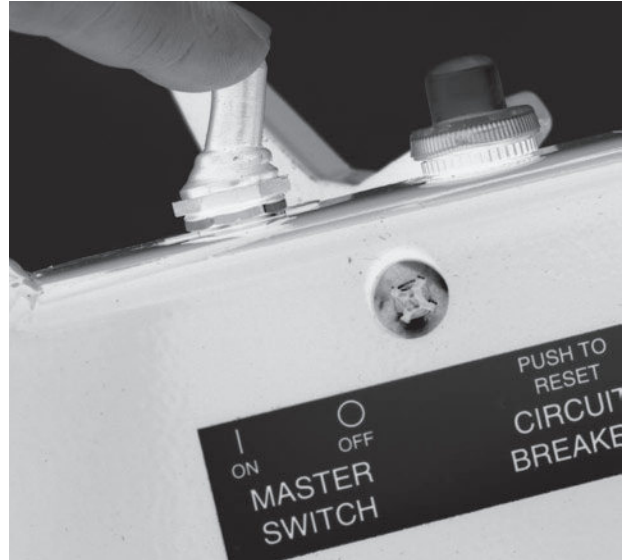

FIGURE 34

OPERATIONAL PARAMETERS AND TECHNIQUES FOR THE CTS12 RIP-R-STRIPPER.

- 1) The specific type and/or density of adhesives, mastics and thin set materials which bond coatings to the work surface can directly affect removal rates. Many adhesives or mastics remain flexible in the fully cured state. These types of materials are usually darker or black in color. The adhesives and mastics which become dried in the fully cured state are usually yellowish or opaque. These materials will usually require less effort to remove than the darker types.
- 2) As a general rule, the thinner the amount of adhesive (ie: the amount used) utilized to adhere the covering to the work surface, the lower the force required to “shear” through the bond and thus, the higher the covering material removal rate.
- 3) As a general rule, the thicker the adhesive (ie: the amount used) utilized to adhere the covering to the work surface, the greater the force required to “shear” through the bond and thus, the lower the covering removal rate. Typically, there will be a greater amount of adhesive residue remaining that will also require removal before the new covering material is installed.
- 4) Typically, adhesive/mastic densities or thicknesses change on the job usually as a result of application rates on the work surface. This, in turn, directly affects bond strengths. As these factors change on work surfaces, the accessory tool angle can be changed by

the operator to help optimize covering material removal rates. As a general rule, thinner adhesive bonds (less adhesive used) will allow the operator to decrease the accessory tool angle relative to the work surface. Thicker adhesive bonds (more adhesive used) will require the operator to increase the accessory tool angle relative to the work surface.

5) Keep the power and extension cords free and clear of the accessory tool while the CTS12 RIP-R-STRIPPER is in operation. Accessory tool contact with the power and/or extension cord can result in damage while creating a potential electrocution concern. In the event of damage, replace the component with a factory approved replacement part only.

WARNING

KEEP THE EXTENSION CORD(S) FREE AND CLEAR OF THE RIP-R-STRIPPER WHILE IN OPERATION. CONTACT WITH THE ACCESSORY TOOL CAN RESULT IN PROPERTY DAMAGE AND/OR PERSONAL INJURY.

WARNING

IN THE EVENT THE POWER AND/OR EXTENSION CORD BECOMES ENTANGLED ABOUT THE RIP-R-STRIPPER AND/OR THE OPERATOR, RELEASE THE CONTROL HANDLE TO ALLOW THE INTERNAL ON/OFF SWITCH TO MOVE TO THE OFF POSITION. FAILURE TO PROPERLY STOP THE RIP-R-STRIPPER IN THIS OPERATING CONFIGURATION CAN RESULT IN PROPERTY DAMAGE AND/OR PERSONAL INJURY. DETERMINE THE EXTENSION CORD AND GFI ARE IN PROPER CONDITION TO CONTINUE OPERATION. REPLACE ANY DAMAGED COMPONENT WITH A FACTORY APPROVED REPLACEMENT PART ONLY.

Service

PREVENTATIVE MAINTENANCE CHECK LIST.

The normal operation of the RIP-R-STRIPPER can produce extreme dirt and dust, along with levels of random vibration. During routine maintenance, the following service list should be accomplished. This list is for reference only and is not intended to be all

inclusive. Other topic areas can be added at the discretion of the owner(s) and/or operator(s):

- 1) Before performing any maintenance, disconnect the RIP-R-STRIPPER from the power source.
- 2) Determine the master ON/OFF switch is in the OFF position. Determine releasing the control handle deploys the internal ON/OFF switch to the OFF position.

WARNING

DISCONNECT THE RIP-R-STRIPPER FROM THE EXTENSION CORD AND/OR POWER SOURCE RECEPTACLE BEFORE PERFORMING ANY SERVICE WORK OR REPAIR. TURN THE MASTER ON/OFF SWITCH TO THE OFF POSITION. DETERMINE RELEASING THE CONTROL HANDLE MOVES THE INTERNAL ON/OFF SWITCH TO THE OFF POSITION. FAILURE TO PROPERLY DISCONNECT THE RIP-R-STRIPPER FROM THE POWER SOURCE DURING THESE ACTIVITIES CAN RESULT IN PROPERTY DAMAGE AND/OR PERSONAL INJURY.

- 3) Remove the accessory tool according to the procedure as outline in this manual.
- 4) Check all fasteners for proper torque values, If a fastener requires retorquing, consult a torque chart for the proper value. Replace any worn fastener with a factory approved replacement part only.
- 5) Inspect the rubber elastomeric handle mounts for damage and/or wear. Mounts are subject to significant loading and vibration levels during the normal operation of the RIP-R-STRIPPER:
 - a) In normal operation, the load capacity of the mounts will decrease over time from wear and environmental-related considerations.
 - b) Mounts have a maximum service limits of 36 months or 250 operational hours, whichever comes first. A maintenance schedule that regularly replaces mounts before failure is experienced will significantly increase ROI and decrease overall maintenance costs.
- 6) Inspect the urethane blocks that secure the electric breaker for damage and/or wear. Blocks are subject to

significant load and vibration levels during normal operation of the RIP-R-STRIPPER:

a) In normal operation, the load capacity of the blocks will decrease over time from wear and environmentally related considerations. The ability of the urethane material to recover or take a permanent “set” decreases the ability to secure the electric breaker in proper position. If normal clamping forces allow the electric breaker to move relative to the mount assembly, the urethane blocks require replacement with factory approved replacement parts only.

b) Urethane blocks have a maximum service limit of 36 months or 250 operational hours, whichever comes first. A maintenance schedule that regularly replaces blocks before failure is experienced will significantly increase ROI and decrease overall maintenance costs.

7) Keep loose materials from accumulating around the electric breaker mount area. Material accumulations will affect machine balance and air flowing through the electric breaker motor which can significantly reduce service life. Keep the air inlets of the electric breaker free and clear of foreign material accumulations. Use a safety type solvent for cleaning the RIP-R-STRIPPER. Do not utilize thinners, benzene or other volatile solvents for cleaning the RIP-R-STRIPPER.

CAUTION

Observe all applicable safety precautions for the solvent.

8) Lubricate the caster wheel bearings with a spray-type, dry film lubricant. Use of other lubricant types can attract foreign materials and reduce bearing service life.

9) Inspect the operator handle for proper structural integrity, including: cracks and abrasions. Replace any questionable component with a factory-approved, replacement part only.

10) Determine that all safety and operational decals (including the applicable Quik-Tips information) is in proper and readable condition. Replace any missing and/or damaged safety or informational decal with a factory-approved, replacement part only.

11) The RIP-R-STRIPPER utilizes antivibration-type handle grips on the operator handle to enhance control and help dampen the forces experienced during the covering material removal process. Determine the handle is equipped with properly fitting grips of sufficient integrity to allow for proper job function as outlined in this manual. Loose fitting handle grips or grips without end caps should be replaced with factory-approved, replacement parts only.

WARNING

DO NOT OPERATE THE RIP-R-STRIPPER WITHOUT PROPERLY FITTED HANDLE GRIPS OF SUFFICIENT STRUCTURAL INTEGRITY INSTALLED ON THE OPERATOR HANDLE. OPERATING THE RIP-R-STRIPPER WITH WORN/DAMAGED GRIPS OR NO HANDLE GRIPS CAN RESULT IN PROPERTY DAMAGE AND/OR PERSONAL INJURY.

LUBRICATION REQUIREMENTS.

Parts Required:

1 each, standard grease gun filled with one of the following: ESSO Beacon 325, Shell Alvana #2, Chevron SRI, or equivalent NLGI #2 grease.

1 each, container of dry film lubricant.

1) Lubricate the caster wheel bearings with a dry film lubricant. These lubricants dry immediately upon contact. Use sparingly. Excess lubricant will attract the fine grained, powdered foreign materials described and directly affect bearing service life. Use of other lubricant types can attract foreign materials that can reduce bearing service life.

CAUTION

Do not lubricate the caster wheels with any lubricant other than a dry film type. Grease, oil and many other liquid type lubricants will attract foreign material accumulations that can reduce bearing service life.

2) Zerk type grease fittings are provided at four locations:

a) Lubrication of the pivot plate bushings: bushings are fabricated from alloy steel and heat treated to minimize wear and to extend service life. Do not over lubricate. Excessive lubrication will attract foreign material accumulations, including abrasive concrete dust, that can reduce component service life. FIGURE 35.



FIGURE 35

b) Lubrication of the extension system end cap bushings: bushings are fabricated from alloy steel and heat treated to minimize wear and to extend service life. Do not over lubricate. Excessive lubrication will attract foreign materials accumulations, including abrasive concrete dust, that can accelerate wear and reduce service life. FIGURE 36.



FIGURE 36

c) Lubrication of the spring assisted locking detent pin contained in the height extension system: the purpose for lubrication is to prevent the formation of rust and other contamination that can affect the wear and resulting service life of the detent pin. Maintain proper lubrication. Excessive lubrication is forced from the assembly. Inadequate lubrication will not provide the necessary protection against rust formation and component wear. Visually inspect the spring assisted locking pin mechanism system on a daily basis for freedom of movement and no indication that an improper amount of lubrication exists. If the detent pin does not properly lock and hold the height adjustment system when actuated by the control lever, determine the cause and corrective action before continued operation. FIGURE 37.



FIGURE 37

d) Excessive grease or excessive grease that has become hardened and dried from lack of operation or proper storage can affect proper operation of the locking detent pin.

3) Grease intervals will vary depending upon machine utilization rates and operating environment factors. Grease accumulations on exterior surfaces would indicate excessive lubrication.

ELECTRIC BREAKER SERVICE.

Contact the manufacturer of the electric breaker for information pertaining to:

- 1) Service and/or repair facility locations.
- 2) Obtain replacement parts.
- 3) Obtain warranty support.

Troubleshooting

ELECTRIC BREAKER.

BREAKER FAILS TO START

Master ON/OFF switch located on operator handle in the OFF position. Turn to ON position.

Electric breaker ON/OFF switch located in the OFF position. Turn to ON/hold position.

Cord plug from operator handle to electric breaker not connected. Inspect for damage and proper connection configuration. Connect cord to extension cord of the electric breaker.

GFI switch at power source activated. Push GFI button to test and rearm. Inspect power source for a fault.

No power received from power source. Check power source for correct voltage and amperage requirements.

Improper extension cord connection (if applicable). Determine all connections produce a closed circuit. Reduce length and/or increase cord AWG size.

ELECTRIC BREAKER LOOSES POWER

Check power source for correct voltage and amperage requirements.

High operating temperatures. Disconnect the electric breaker from the operator handle cord. Determine the electric breaker is clean of foreign material accumulations. Clean as necessary utilizing an appropriate solvent. Allow to cool. Consult material supplied by the specific breaker manufacturer for specific information.

OPERATIONAL PROBLEMS.

ELECTRIC BREAKER FUNCTIONS BUT ACCESSORY TOOL DOES NOT IMPACT AGAINST WORK SURFACE.

Electric breaker internal component failure. Consult breaker manufacturer for specific information.

Top of accessory tool not in contact with electric breaker anvil. Push accessory tool shank upward to

allow proper contact with anvil while in operation. See **STARTING THE CTS12 RIP-R-STRIPPER ON THE JOBSITE.**

Damaged urethane block(s) that secure electric breaker to main frame. Inspect mounts for excessive wear and/or damage. Replace block(s) as necessary. See **INSTALLING THE ELECTRIC BREAKER TO THE MAIN FRAME.**

Retaining clamp screws loose. Inspect and tighten as necessary. See **INSTALLING THE ELECTRIC BREAKER TO THE MAIN FRAME.**

Worn or damaged accessory tool. Determine the tool retaining device properly retains the tool within the receiver.

Worn or damaged tool receiver. Inspect the receiver for excessive wear that allows the tool shank to wedge itself and fail to properly contact the anvil.

EXCESSIVE JUMPING ON THE WORK SURFACE

Incorrect accessory tool installation. See **INSTALLING AN ACCESSORY TOOL TO THE RIP-R-STRIPPER.**

Worn or damaged urethane block(s). Replace as necessary. See **INSTALLING THE ELECTRIC BREAKER TO THE MAIN FRAME.**

Improper accessory tool angle relative to work surface. Manually readjust accessory tool angle during operation to lower/minimize movement.

UNEVEN COVERING MATERIAL REMOVAL

Worn or damaged urethane block(s). Replace as necessary. See **INSTALLING THE ELECTRIC BREAKER TO THE MAIN FRAME.**

Breaker improperly mounted to frame. Reposition as necessary. See **INSTALLING THE ELECTRIC BREAKER TO THE MAIN FRAME.**

Excessive material build-up on caster wheel face surface. Remove material. Readjust wheel scraper to wheel gap setting: 0.3/.06 inch (0.8/1.5 mm) depending upon covering material type and jobsite conditions.

Excessive caster wheel bearing wear. Replace caster wheel.

Excessive axle wear. Replace axle.

Worn or damaged urethane block(s). Replace blocks(s) as necessary. See **INSTALLING ELECTRIC BREAKER TO THE MAIN FRAME.**

Bent or damaged accessory tool. Replace accessory tool.

Storage

Proper procedure for long term storage of the RIP-R-STRIPPER will protect it against the affects of corrosion and damage. If the RIP-R-STRIPPER is not to be operated for a period of 30 days or more, proceed to store as follows:

- 1) Do not store the RIP-R-STRIPPER with the accessory tool installed. Remove the accessory tool according to the procedure as outlined in this manual and store in the accessory tool box if possible.
- 2) Clean all accumulated dirt and grease from the RIP-R-STRIPPER utilizing an appropriate safety solvent.



CAUTION

Observe all applicable safety precautions for the solvent

- 3) Check all visible parts for wear, breakage or damage. Order any part required to make the necessary repair. This will avoid a needless delay when operating the RIP-R-STRIPPER at next use.
- 4) Apply a dry film lubricant to all exposed metal components, including the accessory tool, to prevent the formation of rust.
- 5) Block the bottom of the main frame to prevent machine weight against the urethane blocks. This procedure will reduce impact loads to the blocks, minimize deflection/set and increase service life.
- 5) Store the RIP-R-STRIPPER inside. If the RIP-R-STRIPPER must be stored outside, protect it with a suitable covering.

Specifications

FRAME

STRUCTURE	Unitized, welded steel plate.
DRIVE SYSTEM	Direct impulse, provided by electric breaker.
BREAKER SIZE RANGE	35 to 45 lbs. class.
NUMBER OF URETHANE MOUNTING BLOCK SETS	4
OUTSIDE WHEEL WIDTH	21-3/4 inches (553 mm).
OPERATOR HANDLE WIDTH	30 inches (762 mm).
TRANSPORT LENGTH	28 inches (711 mm), less electric breaker.
HEIGHT	25 inches (635 mm), less electric breaker.

GENERAL

OPERATING ENVIRONMENTS	Non-hazardous type locations as defined by the National Electric Code.
WEIGHT	130 lbs (58 kg), less electric breaker
BREAKER INPUT VOLTAGE	115/220 VAC depending upon specific country/area of location.
AMPERES	15 amperes average draw, Consult material supplied by specific breaker manufacturer.
RATED WATTS	Consult material supplied by specific breaker manufacturer.