

Part No.PL501056100002

Rev: A

May 2022

Operation Manual

GTJZ0608ME/0608ME/1932ME
for Sinoboom Poland

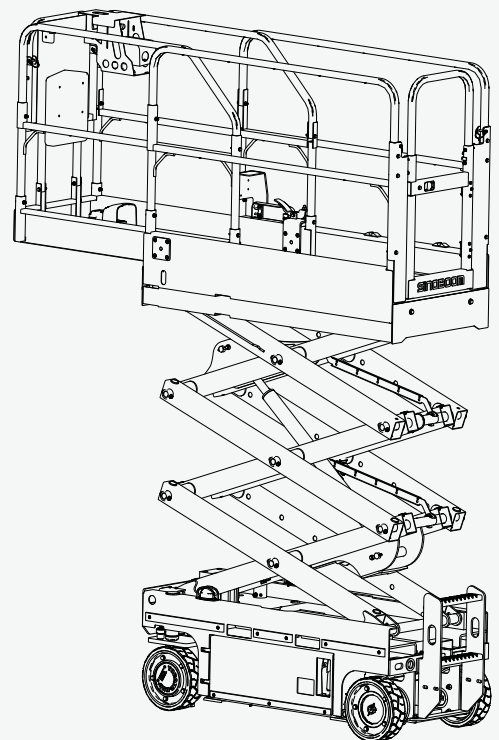

CE *ANSI* AS/NZS  EAC GB 

SINOBOOM

 **WARNING**

Operating, servicing and maintaining this vehicle or equipment can expose you to chemicals including engine exhaust, carbon monoxide, phthalates, and lead, which are known to the State of California to cause cancer and birth defects or other reproductive harm. To minimize exposure, avoid breathing exhaust, do not idle the engine except as necessary, service your vehicle or equipment in a well-ventilated area and wear gloves or wash your hands frequently when servicing. For more information go to: www.P65warnings.ca.gov.
For disposal, please follow your nation regulation.

Manual revision history:

REV	DATE	DESCRIPTION	REMARK
A	May, 2022	Original issue of the manual	

Please contact us:

Website : www.sinoboom.com

E-mail : sales@sinoboom.com

Sales Tel : 0086-0731-87116222

Service Tel : 0086-0731-87116333

Address : No.128, East Jinzhou Avenue, Ningxiang High-tech Industrial Park, Changsha, Hunan, China

Zip Code : 410600

Copyright © Hunan Sinoboom Intelligent Equipment Co., Ltd. All Rights Reserved

The final interpretation right of this manual belongs to Hunan Sinoboom Intelligent Equipment Co., Ltd.

APPLICATION

Use the following table to identify the specific serial number for models included in this manual. Check the model of your machine before consulting the manual, and then use the correct manual according to the serial number of the model. See the nameplate on your machine to identify the model and serial number. (See **Decals/Nameplates Inspection** of the *Operation Manual* for details.)

MODELS	Trade identification		SERIAL NO.
	Metric	Imperial	
GTJZ0608ME	0608ME	1932ME	CE: From PL0106900100 to Present ANSI/CSA: From PL0105600100 to Present

NOTE:

- Product model is applied in product nameplate for distinction of products of different main parameters.
- Product trade identification is applied in marketing and machine decals for distinction of products of different main parameters, and can be classified as metric type and imperial type: The metric type of trade identification is applicable to machines for countries/regions using metric system or as specially required by customers; The imperial type of trade identification is applicable to the machines for countries/regions using imperial system or as specially required by customers.

STATEMENTS

Hunan Sinoboom Intelligent Equipment Co., Ltd. (Hereinafter referred to as Sinoboom) will upload the latest product manual information to the website www.sinoboom.com as soon as possible. However, due to continuous product improvement, the information in this manual is subject to change without prior notice.

This manual covers the basic parts information of one or more products. Therefore, please use this manual according to your needs. If you find problems in the manual or have suggestions for improvement, feel free to share your feedback with Sinoboom, and we will address these issues as soon as possible.

Feel free to consult and download the *Operation Manual*, *Maintenance Manual* and *Parts Manual* of the products you need online at www.sinoboom.com.

Hunan Sinoboom Intelligent Equipment Co., Ltd. retains the right of final interpretation of the manual.

SINOBOOM



All of the above are registered trademarks of Hunan Sinoboom Intelligent Equipment Co., Ltd..

TABLE OF CONTENTS

Introduction	iii	Testing the Platform Controller (SINOBOOM)	6-3
1 Machine Specifications	1-1	Testing the Platform Controller (DTC)	6-5
2 Machine Components	2-1	Testing the Drive Speed	6-7
3 Safety	3-1	Testing the Emergency Lowering Function	6-8
Safety Definitions	3-1	Testing the Tilt Protection Function ...	6-9
Reporting Accidents	3-1	Testing the Pothole Guard	6-10
Electrocution Hazards	3-2	Testing the Weighing System (optional)	6-10
Tipping Hazards and Rated Load	3-2	7 Operating the machine	7-1
Work Environment Hazards	3-4	Emergency Stop	7-1
Unsafe Operation Hazards	3-5	Using the Emergency Lowering Feature	7-2
Fall Hazards	3-6	Emergency Towing/Dragging	7-2
Collision Hazards	3-7	Operation from Ground	7-3
Crush Hazards	3-8	Operation from Platform	7-3
Explosion and Fire Hazards	3-8	SINOBOOM system	7-3
Damaged Machine Hazards	3-8	DTC system	7-4
Bodily Injury Hazards	3-9	Operating with the Platform Controller on the Ground	7-5
Battery Hazards	3-9	Extending/Retracting the Platform	7-5
Welding and Polishing Requirements	3-10	Folding/Unfolding the Rails	7-5
After Using the Machine	3-11	Driving on a Slope	7-6
4 Jobsite Inspection	4-1	Charging the Battery	7-6
5 Pre-operation Inspection	5-1	Charger Operating Instructions	7-8
Tips for Conducting a Pre-operation Inspection	5-1	Delta-q Charger	7-8
Conducting a Pre-operation Inspection	5-2	Green Power Charger	7-8
Inspecting Parts	5-2	Selecting A Charge Profile	7-9
Inspecting Entire Machine	5-2	Delta-q Charger	7-9
Inspect Hydraulic Oil Level	5-2	Green Power Charger	7-9
Inspect Battery Level	5-3	8 Transporting and Lifting the Machine	8-1
6 Pre-operation Function Test ..	6-1	Lifting the Machine with a Forklift	8-1
Preparing for a Pre-operation Function Test	6-1		
Testing the Ground Controller	6-1		

Lifting the Machine with a Crane	8-2
Transporting the Machine	8-2
9 Maintenance	9-1
Conducting a Pre-delivery Inspection .	9-1
Following a Maintenance Schedule . . .	9-2
Completing a Repair & Inspection Report	9-2
10 Decals/Nameplates	
Inspection	10-1
Decals/Nameplates (CE-Metric) . . .	10-2
Decals/Nameplates (CE-Imperial) .	10-5
Decals/Nameplates (CE-PL)	10-8
Decals/Nameplates (CSA)	10-11
Decals/Nameplates (ANSI)	10-14
Appendix 1: Symbols and Description	A-1
Appendix 2: Prepare the Work Record Before Delivery	A-5
Appendix 3: Repair & Inspection Report	A-7

INTRODUCTION

Thank you for choosing and using the machinery of Hunan Sinoboom Intelligent Equipment Co., Ltd. Always read, understand and become familiar with the operation requirements of the machine and its associated safety procedures before operating, maintaining and repairing the machine. Operating the machine without becoming familiar with its specific operation requirements and safety procedures poses serious risks. Operators who follow safety rules and operate the machine carefully and effectively will prevent personal injury, property loss and accidents.

Use this machine only to transport tools to work locations and for performing tasks on the work platform. Operators must be competent and must obtain training to carefully use the machine and follow safety procedures. Only trained and authorized personnel may operate the machine.

This manual guides the operator in operating and using the machine. The operator is responsible for reading, understanding and implementing the operation and safety procedures in this manual and for following the manufacturer's instructions before beginning any work. Read, understand and follow all safety rules and operating instructions. The operator must also consider the machine's uses and limitations and the conditions at the jobsite before using this machine. Strictly following all safety requirements in this manual is critical.

Consider this manual a part of the machine, along with *Maintenance Manual* and *Parts Manual*, and always keep the manuals with the machine. The owner or administrator of the machine shall offer all manuals and other necessary information provided by the machine manufacturer regarding the daily inspection and maintenance to each of the renters. If the machine is sold, the owner or administrator must pass along the manuals and other necessary information to the purchaser. The owner or administrator of the machine shall also provide the manufacturer's maintenance information to the person responsible for maintaining the machine.

If you have any questions, contact Hunan Sinoboom Intelligent Equipment Co., Ltd..

1 MACHINE SPECIFICATIONS

Table 1-1 GTJZ0608ME Specifications

MEASURE		0608ME (METRIC)		1932ME (IMPERIAL)	
DIMENSION					
Max. platform height		5.8m		19ft	
Max. working height		7.8m		25ft 7in.	
Max. horizontal extension		0.9m		3ft	
Overall length-stowed	Fold-down platform	Rails down	1.8m	5ft 11in	
		Rails up	1.8m	5ft 11in	
	Quick fold-down platform	Rails down	1.9m	6ft 3in	
		Rails up	1.8m	5ft 11in	
Overall width-stowed		0.81m		2 ft 8in	
Overall height-stowed	Fold-down platform	Rails down	1.88m	6ft 7in	
		Rails up-AS models	2m	6ft 6 in	
		Rails up	2.14m	7ft	
	Quick fold-down platform	Rails down	1.97m	6ft 5.6in	
		Rails up	2.14m	7ft	
		Wheel base		1.334m	
Wheel span		0.71m		2.ft 4in	
Ground clearance (pothole guards retracted)		75mm		3in.	
Ground clearance (pothole guards deployed)		24mm		0.95in.	
Tire size (diameter × width / type)		Φ323×100mm/solid		Φ12.7×4in/solid	
Platform dimension (Length × Width × height)		1.64×0.76×1.1m		5ft 4.6in×2ft 6in×3ft 7in	
Platform dimension (AS models)		1.64 m×0.76 m×0.96m		5 ft 4.6 in*2 ft 6 in*3 ft 1.8 in	
PERFORMANCE					
Rated platform capacity		230kg		507 lb	
Max capability of extension platform		120kg		265 lb	
Max. platform occupancy (indoor/outdoor)		2 persons (indoor)/1 person (outdoor)			
Drive speed (stowed)		0 ~ 4km/h		0 ~ 2.5 mph	
Drive speed (raised)		0 ~ 0.8 km/h		0 ~ 0.5 mph	
Uptime (in a no-load state)		15 ~ 20 s			
Downtime (in a no-load state)		25 ~ 30 s			

Table 1-1 GTJZ0608ME Specifications (continued)

MEASURE	0608ME (METRIC)	1932ME (IMPERIAL)
Gradeability	25%	
Max. allowable inclination	3° (Front to back)/1.5° (Left to right)	
Turning radius (inside)	0m	0 ft
Turning radius (outside)	1.49m	4ft 10.7in.
Max. allowable manual force (indoor/outdoor)	400N (indoor)/200N (outdoor)	90 lbf (indoor)/45 lbf (outdoor)
Max. noise	72dB	
POWER		
Hydraulic tank capacity	6L	1.3 gal (imperial)/1.6 gal (US)
Hydraulic system capacity (including tank)	7L	1.5 gal (imperial)/1.8 gal (US)
Hydraulic system pressure	21MPa	3046 psi
Battery specification (quantity × voltage, capacity)	4×6V, 225Ah	
System voltage	24VDC	
Control voltage	24VDC	
GROUND BEARING DATA		
Max wheel load	700 kg	1543 lb
Pressure against ground	1230 KPa	178 Psi
ENVIRONMENT		
Max. allowable wind speed (indoor/outdoor)	0m/s (indoor)/12.5m/s (outdoor)	0mph (indoor)/28 mph (outdoor)
Max. allowable altitude	1000m	3280.8ft
Allowable ambient temperature (lead-acid batteries)	-10°C to 40°C	14°F to 104°F
Allowable ambient temperature (lithium batteries)	-20°C to 40°C	-4°F to 104°F
Max. allowable ambient relative humidity	90%	
Storage condition	Stored at -20°C to 50°C (-4°F to 122°F) in a well-ventilated environment with 90% relative humidity (20°C [68°F]), and away from rain, sun, corrosive gas and inflammable explosive.	
WEIGHT		

Table 1-1 GTJZ0608ME Specifications (continued)

MEASURE	0608ME (METRIC)	1932ME (IMPERIAL)
Weight (in a no-load state) (indoor/outdoor)	1575kg	3473 lb

NOTE:

- a) The working height adds 2m (6ft 7in) of human height to platform height.
- b) In different areas, hydraulic oil, engine oil, coolant, fuel and lubrication should be added in accordance with the environmental temperature.
- c) In cold weather, auxiliary devices are needed to start the machines.
- d) The ground bearing data is approximate values not considering different options and only used when it is safe enough.
- e) The loads of persons, accessories, tools and materials are factored into the rated platform capacity.

2 MACHINE COMPONENTS

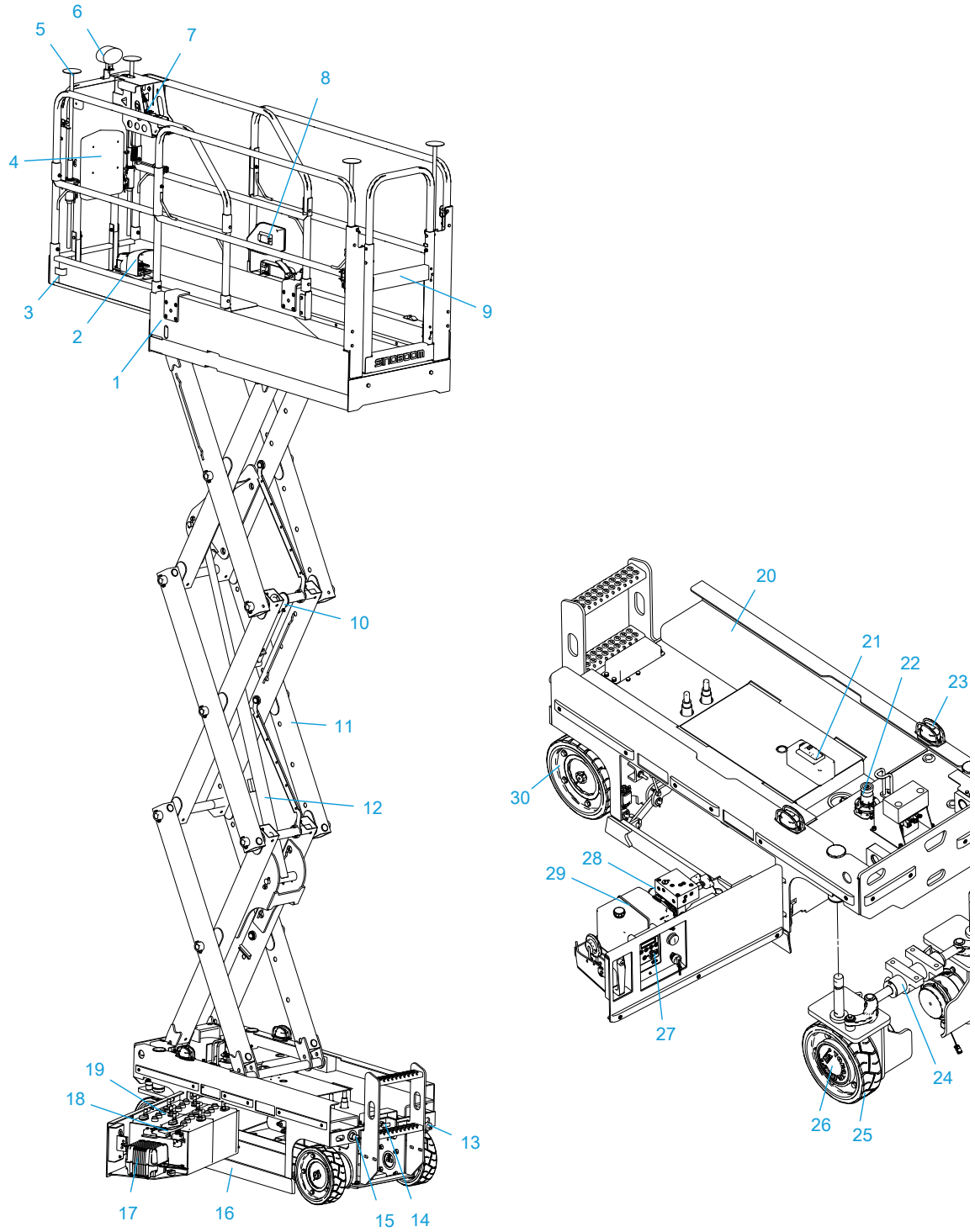

Figure 2-1

Component	China	CE	CSA	ANSI	AS	Japan	Korea	Poland
1. Fixed Platform					√			
2. Foot Switch							√	
3. Extended Platform					√			
4. Manual Storage Container					√			
5. Overhead Protection							√	
6. Working Light								√
7. Platform Control Box					√			
8. AC Power Socket				√				√
9. Platform Entry Gate					√			
10. Safety Arm					√			
11. Scissor Components					√			
12. Lift Cylinder					√			
13. Industrial Plug					√			
14. Emergency Decent Handle					√			
15. Charger Plug					√			
16. Pothole Protection Plate					√			
17. Battery charger					√			
18. Main Power Handle Assembly					√			
19. Battery					√			
20. Chassis					√			
21. RCBO		√		√				√
22. Level Sensor					√			
23. Flash Light				√				√
24. Steer Cylinder					√			
25. Steer Wheel					√			
26. Drive Reducer, DC					√			
27. Ground Controller					√			
28. Power Unit					√			
29. Hydraulic Oil Tank					√			
30. Rear Wheel					√			

Machine positions**Stowed position:**

The machine comes in stowed position when fully retracted.

Non-operating position:

The machine remains in non-operating position when the down limit switch does not disengage.

Operating/raised position:

The machine comes in operating/raised position when the platform is raised until the down limit switch disengages.

Note: The platform height (from ground to platform floor) with the down limit switch disengaged: $3\pm 0.3\text{m}$ (9ft 10in $\pm 12\text{in}$)

3 SAFETY

Read, understand and comply with the safety rules and regulations of your workplace and your government.

Before using the machine, ensure the operator is properly trained and qualified in safely operating the machine. The training includes but is not limited to :

- Warning and instruction decals on the machine
- Pre-operation inspection
- Any factors that may affect the machine stability
- Common hazards and countermeasures
- Jobsite inspection
- Functions of all controls and associated knowledge, including emergency control.
- Personal protection equipment that suits the task, workplace and environment.
- Safety operation
- Transporting the machine
- Measures against unauthorized use
- Operating instructions

Understand that as the operator you have the responsibility and right to shut down the machine in case of failure with the machine or other emergency at your workplace.

NOTICE

People suffering from heart disease, hypertension, epilepsy and other diseases and people who fear heights must never operate or use this machine. Also, people who have alcohol or drugs in their system, or experience excessive fatigue or depression, are prohibited from operating or using this machine.

SAFETY DEFINITIONS



This safety alert symbol appears with most safety statements. It means attention, become alert, your safety is involved! Please read and abide by the message that follows the safety alert symbol.

DANGER

Indicates a hazardous situation that, if not avoided, **will** result in death or serious injury.

WARNING

Indicates a hazardous situation that, if not avoided, **could** result in death or serious injury.

CAUTION

Indicates a hazardous situation that, if not avoided, **could** result in minor or moderate injury.

NOTICE

Indicates a situation that can cause damage to the engine, personal property and/or the environment, or cause the equipment to operate improperly.

NOTE: Indicates a procedure, practice or condition that should be followed in order for the engine or component to function in the manner intended.

REPORTING ACCIDENTS

In case of any accident involving the machine of Hunan Sinoboom Intelligent Equipment Co., Ltd., notify Hunan Sinoboom Intelligent Equipment Co., Ltd. immediately, even if no personal injury or property damage occurs in the accident. Contact Hunan Sinoboom Intelligent Equipment Co., Ltd. by telephone and provide all necessary details. Failure to notify the manufacturer within 48 hours of the incident involving the machine of Hunan Sinoboom Intelligent Equipment Co., Ltd. may void the product's warranty.

NOTICE

Thoroughly inspect the machine and all its functions after any accident. Make sure to test it first from the ground controller and then from the platform controller. Ensure the machine's lifting height does not exceed 3 m (9.8 ft) until all damage has been repaired and all controllers operate properly.

ELECTROCUTION HAZARDS

NOTE: This machine is not insulated and does not have an electric shock protection function.

All operators and managers shall comply with national or local regulations regarding the minimum safe distance of live conductors above the ground. In the absence of such requirements, operators and managers should follow the minimum safety distance requirements in [Table 3-1 Minimum Safe Distance, page 3-2](#).

WARNING

ELECTRICAL SHOCK HAZARDS

- Always maintain a safe distance from power lines and electrical equipment in accordance with applicable government regulations and see [Table 3-1 Minimum Safe Distance, page 3-2](#).
- Consider platform movement, wire swinging or drooping, beware of strong winds or gusts, and do not operate the machine when there is lightning or heavy rain.
- If the machine comes into contact with live wires, keep away from the machine. Personnel on the ground or on the platform must not touch or operate the machine until the power is switched off.
- Do not use the machine as a ground wire during welding and polishing operations.

TIPPING HAZARDS AND RATED LOAD

Maximum rated load bearing capacity of the platform:

Table 3-2

GTJZ0608ME&0608ME	
Retracting	230 kg (507 lb)
Extending: Stationary only	110 kg (242 lb)
Extending: Extension only	120 kg (265 lb)

Table 3-1 Minimum Safe Distance

Voltage (Phase to Phase, kV)	Minimum Safe Distance (m/ft)
0-50	3.05 (10)
50-200	4.60 (15)
200-350	6.10 (20)
350 -500	7.62 (25)
500 -750	10.67 (35)
750 -1000	13.725 (45)

 **WARNING**



TIPPING HAZARDS

- Personnel, equipment and materials on the platform must not exceed the maximum load capacity.
- Only raise or extend the platform when the machine is on solid, level ground.
- Do not use the tilt alarm as a level indicator. The tilt alarm on the platform will sound only if the machine is heavily tilted. If the tilt alarm sounds:
 - Be very careful to lower the platform. Transfer the machine to solid, level ground. Do not change the level or limit switch.
- Do not drive faster than 0.8 km/h (0.5 mph) when the platform is raised.
- When the platform is raised, the machine cannot travel on uneven terrain, unstable surfaces or in other dangerous conditions.
- Do not operate the machine during strong winds or gusts, and do not increase the surface area of the platform or load. Increasing the area exposed to the wind will reduce the stability of the machine.
- When the machine is on rough ground, with gravel or other uneven surfaces, or near holes and steep slopes, use caution and reduce the speed.
- When on the platform do not push and pull objects outside of it. The maximum lateral force allowed is:

GTJZ0608ME: 400 N(90 lbf) in-
door/200 N(45 lbf) outdoor

- Do not change any machine parts that may affect safety and stability.
- Do not replace key parts that affect machine stability with different weights or specifications.

 **WARNING**





TIPPING HAZARDS

- Do not modify or change moving aerial platforms without the manufacturer's prior written permission.
- On the platform, do not attach an additional device for placing tools or other materials to the guardrail. This will increase the platform weight, surface area and load.
- Do not place on, or fasten to, any overhanging load to any part of this machine.
- Do not place ladders or scaffolding on the platform or any parts of the machine.
- Do not use the machine on a moving or active surface or on a vehicle. Ensure all tires are in good condition, the slotted nuts tightened and the cotter pins complete.
- Do not use a battery that weighs less than the original lead acid battery (28 kg [62 lb]) or lithium battery (50 kg [110 lb]). The battery not only provides power, it also serves as a counterweight. The battery is vital to maintaining the stability of the machine.
- Do not use a platform to propel machines or other objects.
- Do not let the platform touch nearby objects.
- Do not tie off the platform with rope or other binding materials to nearby objects.
- Do not put a load outside the platform.
- Do not operate the machine when the chassis doors are open.
- When the platform is caught or stuck or when other objects in the vicinity impede its normal movement, do not use the platform controller to lower the platform. If you intend to lower the platform with a ground controller, you must operate it only after all personnel have left the platform.

WORK ENVIRONMENT HAZARDS

 **WARNING**

UNSAFE JOBSITE HAZARDS

- Do not operate the machine on surfaces, edges or potholes that cannot bear the weight of the machine. Raise or extend the platform only when the machine is on firm, flat ground.
- Do not use the tilt alarm as a horizontal indicator. The tilt alarm on the platform will sound only when the machine is heavily tilted.
- If the tilt alarm sounds while lifting the platform, be very careful when lowering the platform. Do not change the level or limit switch.
- Running speed should not exceed 0.8 km/h (0.5 mph) when the platform rises.
- If the machine can be used outdoors, never operate it during strong winds or gusts. Do not lift the platform when the wind speed exceeds 12.5 m/s (28 mph). If the wind speed exceeds 12.5 m/s (28 mph) after the platform is lifted,

 **WARNING**

UNSAFE JOBSITE HAZARDS



- fold the platform and do not continue to operate the machine.
- Never travel on uneven terrain or unstable surfaces or in other dangerous conditions when raising the platform.
- When the machine retracts, be careful and slow down when the machine is moving on uneven terrain, crushed stone, unstable or smooth surfaces, steep slopes and near cave entrances.
- Do not drive or lift the machine on slopes, steps or vaulted surfaces that exceed the maximum climbing capacity of the machine.

Before or during machine operation, check the possible hazards on the jobsite and beware of the restrictions within the environment, including flammable and explosive gas/dust. If the machine is used in any other applications, or by any other means, as specified by **Sinoboom**, it must be approved or guided by the manufacturer.

Table 3-3

BEAUFORT NUMBER	METERS/SECOND	MILE/HOUR	DESCRIPTION	GROUND CONDITION
0	0 ~ 0.2	0 ~ 0.5	Calm	Calm. Smoke rises vertically.
1	0.3 ~ 1.5	1 ~ 3	Light air	Wind motion visible in smoke.
2	1.6 ~ 3.3	4 ~ 7	Light breeze	Wind felt on exposed skin. Leaves rustle.
3	3.4 ~ 5.4	8 ~ 12	Gentle breeze	Leaves and smaller twigs in constant motion.
4	5.5 ~ 7.9	13 ~ 18	Moderate breeze	Dust and loose paper rise. Small branches begin to move.
5	8.0 ~ 10.7	19 ~ 24	Fresh breeze	Smaller trees sway.
6	10.8 ~ 13.8	25 ~ 31	Strong breeze	Large branches in motion. Flags waving near horizontal. Umbrella use becomes difficult.
7	13.9 ~ 17.1	32 ~ 38	Near gale/moderate gale	Whole trees in motion. Effort needed to walk against the wind.

BEAUFORT NUMBER	METERS/ SECOND	MILE/ HOUR	DESCRIPTION	GROUND CONDITION
8	17.2 ~ 20.7	39 ~ 46	Fresh gale	Twigs broken from trees. Cars veer on road.
9	20.8 ~ 24.4	47 ~ 54	Strong gale	Light structure damage.

NOTICE

Maximum climbing ability is suitable for machines with platform retracted.

Maximum Slope:

GTJZ0608ME: 25% (14°)

Climbing capacity means the maximum allowable tilt angle of the machine when it is on solid ground and the platform is only capable of carrying one person. As the weight of the machine's platform increases, the machine's climbing capacity reduces.

UNSAFE OPERATION HAZARDS

At a minimum, operators must operate and maintain the machine as stated in this manual and in the *Maintenance Manual* in addition to following more stringent industry regulations and workplace rules. Never engage in unsafe machine operation.

Do not use the machine in the following situations :

- Unrelated personnel/equipment is present in the working envelope of the machine.
- Use as a crane (except the custom-made ones with such functions).
- Use on the truck, trailer, tracked vehicle, ship, scaffold and the like without written consent by the manufacturer or a qualified professional.
- Improper securing of the machine to another object by just sitting it against, fastening or binding.
- Stunt or imprudent use of the machine.
- Overloaded or over-moment situation.
- Other situations as specified in the Manuals.

⚠ WARNING

UNSAFE OPERATION HAZARDS



- Do not push any object outside the platform. The maximum lateral force allowed is:

- GTJZ0608ME: 400 N(90 lbf) indoor/200 N(45 lbf) outdoor

- Do not change any machine parts that may affect safety and stability.
- Do not replace key parts that affect machine stability with different weights or specifications.
- Do not change or modify moving aerial platforms without the manufacturer's written permission.
- On the platform, do not attach an additional device for placing tools or other materials to the guardrail. This will increase the platform weight, surface area and load.
- Do not put ladders or scaffolding on the platform or any part of this machine.
- Do not use the machine on any mobile or movable surface or vehicle. Ensure all tires are in good condition, the slotted nuts tightened and the cotter pins complete.
- Do not use a battery that weighs less than the original lead acid battery (28 kg [62 lb]) or lithium battery (50 kg [110 lb]). The battery not only provides power, it also serves as a counterweight. The battery is vital to maintaining the stability of the machine.
- Do not place or attach any suspended load onto any part of the machine.
- Do not use the machine as a crane.
- Do not use the platform to push the machine or other objects.
- Do not allow the platform to touch nearby objects.



⚠ WARNING

UNSAFE OPERATION HAZARDS

- Do not tie the platform onto nearby objects.
- Do not put the load outside the platform.
- When the platform is caught or stuck or when other objects in the vicinity impede its normal movement, do not use the platform controller to lower the platform. If you intend to lower the platform with a ground controller, you must operate it only after all personnel have left the platform.



- Do not operate the machine when the chassis door box is open.
- When one or more of the machine's tires are off the ground, evacuate all personnel before attempting to stabilize the equipment. Use a crane, forklift or other suitable apparatus to stabilize the equipment.

FALL HAZARDS

At a minimum, operators must operate and maintain the machine as stated in *Operation Manual* and in the *Maintenance Manual* in addition to following more stringent industry regulations and workplace rules.

⚠ WARNING

FALL HAZARDS











- Each person on the platform must wear harnesses or use safety equipment consistent with government regulations. Fasten the cable to the fixed point of the platform. Never fasten the cable of more than one person to a fixed point on the platform.
- Do not sit, stand or crawl on the guardrails. When on the platform always remain standing on the platform floor.
- Do not climb down from the platform when the platform is elevated.
- Keep the platform floor free of obstacles.
- Do not enter or exit the platform unless the machine is fully in place.
- Close the platform entrance door before operating the machine.
- Do not operate the machine if the handrails are not properly installed and the platform entry door is not closed.

COLLISION HAZARDS

At a minimum, operators must operate and maintain the machine as stated in the *Operation Manual* and in the *Maintenance Manual* in addition to following more stringent industry regulations and workplace rules.

⚠ WARNING

COLLISION HAZARDS

- Pay attention to the field of sight and the presence of blind spots when moving or operating the machine.
- Pay attention to the extended platform when moving the machine.
- Check the work area to avoid ground and overhead obstructions or other possible risks.
- Be sure to exercise caution when using the platform controller and chassis controller. Color-marked directional arrows show the function of travel, lift and steering.
- Users must comply with user, workplace and government rules regarding the use of personal protective equipment (hard hats, safety belts and gloves, etc.).
- Place the machine on level ground or in a secured position before releasing the brakes.
- Only lower the platform when there are no people or obstructions in the area beneath it.
- Limit the speed of travel according to ground conditions, crowding, gradients, the presence and location of personnel and any other factors that may cause collisions.
- Do not operate the machine on any crane or overhead traveling device unless the crane control is locked or precautions have been taken to prevent any potential collision.
- Do not place your hands and arms where they may become crushed or trapped.
- Do not work in or under the platform or near the scissor arms when the safety lever is not in place.
- Maintain good judgment and planning when using the controller on the ground to operate the machine. Maintain proper distance between operator, machine and fixed object.

⚠ WARNING**COLLISION HAZARDS**

- Never operate a machine dangerously or for fun.

CRUSH HAZARDS

A potential crush hazard exists during movement of the machine. Always keep body parts and clothing a safe distance from the machine during machine operation.

⚠ WARNING**CRUSH HAZARDS**

- Do not place your hands and arms where they may become crushed or trapped.
- Do not work in or under the platform or near the scissor arms when the safety lever is not in place.
- Maintain good judgment and planning when using the controller on the ground to operate the machine. Maintain proper distance between operator, machine and fixed object.

EXPLOSION AND FIRE HAZARDS**⚠ WARNING****EXPLOSION AND FIRE HAZARD**

- Do not use the machine or charge the battery in hazardous or potentially flammable or explosive atmospheres.
- For the engine-powered machines, never add fuel while the engine is still running, and only add fuel when the place is well ventilated and free of flame, spark or any other hazards that may cause explosion.
- Never spray ether on the engine equipped with glow plug.

DAMAGED MACHINE HAZARDS**NOTICE**

To avoid machine damage, follow all operation and maintenance requirements in the Operation Manual and the Maintenance Manual.

⚠ WARNING

UNSAFE OPERATION HAZARDS



- Do not use the machine if it is damaged or not in proper operating condition.
- Thoroughly inspect and test for all functions of the machine before use. Immediately mark and stop damaged or faulty machines.
- Ensure that all maintenance operations have been performed in accordance with the *Operation Manual* and the corresponding *Maintenance Manual*.
- Make sure all labels are in place and are legible.
- Ensure that the *Operation Manual* and *Maintenance Manual* are sound, easy to read and stored in the storage compartment on the platform.

BODILY INJURY HAZARDS

Always follow all operation and maintenance requirements in the *Operation Manual* and the *Maintenance Manual*.

⚠ WARNING

UNSAFE OPERATION HAZARD





Do not operate the machine when there are oil spills/leaks. Oil spills or leaks in hydraulic fluids may penetrate and burn the skin.

NOTE: The operator must carry out maintenance during the pre-operation inspection only. During operation, keep the left and right doors of the chassis closed and locked. Only trained service personnel can open the left and right doors to repair the machine.

BATTERY HAZARDS

⚠ WARNING

FIRE AND EXPLOSION HAZARD

- Batteries contain sulfuric acid and generate explosive mixtures of hydrogen and oxygen gases. Keep any device that may cause sparks or flames (including cigarettes/smoking materials) away from the battery to prevent explosion.
- Do not touch the battery terminals or cable clips with tools that may cause sparks.

⚠ WARNING

BATTERY HAZARD



Always wear protective glasses or goggles and protective clothing when working with batteries. Remove all rings, watches and other accessories.

⚠ WARNING

CHEMICAL BURN HAZARD



Avoid spilling or contacting battery acid with unprotected skin. Seek medical attention immediately if battery acid contacts skin.

 **WARNING**
BATTERY HAZARD

- Only connect the charger to a grounded 3–wire AC outlet. Be sure the charger is in proper operating condition before charging.
- Only use the charger provided with the machine by the manufacturer.
- Ensure the place where the battery is charged is well ventilated and far away from sunlight, flame, spark or any other hazards that may cause explosion, and do not expose the battery to the water or rain.
- Only the properly trained personnel authorized by the workplace are allowed to remove the battery from the machine.
- Be sure to use the appropriate number of personnel and proper lifting methods when changing the battery.
- During the assembling or disassembling process, never use the battery in a forcible manner, and never allow the battery to fall off.
- Never directly short-circuit the battery outputs with electrical cords.
- Should the battery acid spill out, use bicarbonate (baking soda) mixed with water to neutralize the acid.
- Never store the battery in water or humid atmosphere.
- Daily check the battery cable for damage, and replace any damaged parts before operating the machine.

 **WARNING**
LITHIUM BATTERY HAZARD

- Only use the dedicated charger to charge the battery.
- Do not allow lens, needles or other sharp objects to contact with the battery, otherwise the battery membrane will easily get damaged.
- Do not immerse the battery into the sea or water for an extended period of time.
- Do not use the machine with the battery close to a heat source (- fire, heater, etc).
- Do not use the battery with the positive or negative terminals installed inversely.
- Do not directly connect the battery to a power outlet .
- Do not throw the battery into a fire or heater,

NOTICE

After charging the battery, be sure that:

- The battery cable connections are free of corrosion.
- The battery hold-down and cable connections are secured.

Adding terminal protection and anti-corrosion sealants will help reduce corrosion of the battery terminals and cables.

WELDING AND POLISHING REQUIREMENTS

Before welding, grinding and polishing operations, always ensure you read and understand all operation and maintenance requirements in the *Operation Manual* and the *Maintenance Manual*.

⚠ WARNING

WELDING HAZARDS



- Comply with the welder manufacturer’s recommendations for procedures concerning proper use of the welder.
- Welding leads or cables may only be connected after turning off the power unit.
- Carry out welding operations only after the welding cable has been correctly connected.
- Do not use the machine as a ground wire during welding operation.
- At all times, make sure that the power tools are completely stored in the working platform. Do not hang the power tools on the railing of the working platform or the work area outside the working platform, or hang the power tools directly by the wire.

Before performing welding, grinding and polishing work, welders must seek permission of the responsible department at the workplace.

AFTER USING THE MACHINE

1. Choose a safe parking location that is on sturdy, level ground and that is free of obstructions. Avoid areas with heavy traffic.
2. Lower the platform.
3. Turn the emergency stop switch of the ground controller to the “OFF” position
4. Turn the key switch to the “OFF” position and remove the key to avoid unauthorized use of the machine.
5. Block the wheels with the wheel wedges.
6. Charge the battery.

NOTICE

After using the machine, the power off switch must be disconnected.

4 JOBSITE INSPECTION

 **WARNING**

UNSAFE OPERATION HAZARD

 **Be sure to follow the instructions and safety rules in this manual. Failure to follow the instructions and safety rules in this manual may result in death or serious injury.**

Do not operate this machine unless you have learned and practiced the rules for safely operating the machine as stated in this manual.

- **Know and understand the safety rules before continuing the next step.**
- **Avoid dangerous situations.**
- **Always check the machine before operating.**
- **Select appropriate machinery and personal protective equipment (hard hats, safety belt and gloves, etc.) for the task.**
- **Always perform a pre-operation function test before using the machine.**
- **Check the work site.**
- **Check the safety decals/ name-plate on the machine.**
- **Only use the machine according to the instructions in this manual and for its intended purpose.**

- Unstable or ultra-smooth surfaces
- Overhead obstacles and high-voltage wires
- Hazardous locations
- Ground surface that could fail to support the capacity of the machine and its load
- Gusts and strong winds
- Actions by unauthorized personnel
- Other possible unsafe conditions

During the jobsite inspection the operator determines whether the jobsite is suitable for safe machine operation. The operator should conduct the jobsite inspection before moving the machine to the jobsite.

Safety is the operator's responsibility. Part of safety is conducting a thorough jobsite inspection. Operators must identify and avoid workplace hazards when moving, installing and operating the machine.

Unless approved by Sinoboom, never operate the machine in a hazardous site. The following items present danger on the jobsite:

- Steep hills or caves
- Ground prominences, obstacles or debris
- Ground inclines

5 PRE-OPERATION INSPECTION

WARNING

UNSAFE OPERATION HAZARD



Be sure to follow the instructions and safety rules in this manual. Failure to follow the instructions and safety rules in this manual may result in death or serious injury.

Do not operate this machine unless you have learned and practiced the rules for safely operating the machine as stated in this manual.

- Know and understand the safety rules before continuing the next step.
- Avoid dangerous situations.
- Always check the machine before operating.
- Select appropriate machinery and personal protective equipment (hard hats, safety belt and gloves, etc.) for the task.
- Always perform a pre-operation function test before using the machine.
- Check the work site.
- Check the safety decals/ nameplates on the machine.
- Only use the machine according to the instructions in this manual and for its intended purpose.

Before operating the machine, please first understand the tasks to be done and be aware of the following :

1. Be familiar with each function of the machine and capable of operating it adeptly.
2. Only the person authorized by the management is allowed to operate the machine.
3. Obey the safety rules in this manual, and fully understand and follow the operating instructions in this manual to operate the machine.
4. The operator should go through a professional training based on this operation manual, and should be certified as a qualified operator in operation of this machine.

5. Clearly understand all nameplates, warning and safety decals on the machine.
6. Before each operation, examine and check the operational environment, and ensure the safety protection equipment is properly in place. The safety equipment may differ according to the operational environment.
7. Before operating the machine, be sure that all control handles are returned to neutral, and all switches in the OFF position.

TIPS FOR CONDUCTING A PRE-OPERATION INSPECTION

- The operator is responsible for performing the “pre-operation inspection” and routine maintenance as stated in this manual.
- Before each shift change, the operator must conduct a pre-operation inspection to find out whether the machine has obvious problems before the operator performs a pre-operation function test.
- The pre-operation inspection also helps the operator determine whether the machine requires routine maintenance.
- See the list of machine components on [2 Machine Components, page 2-1](#). Check the machine for any modified, damaged, loose or missing parts.
- Never use a machine that has damaged or modified parts. Mark the machine and stop using the machine if you discover damage or modifications.
- Only qualified maintenance technicians can repair the machine according to the manufacturer's regulations. After any maintenance, the operator must perform another pre-operation inspection before conducting a pre-operation function test.
- Qualified maintenance technicians must perform regular maintenance inspections according to the requirements in the manufacturer's *Maintenance Manual*.

 **WARNING**



TIPPING HAZARD

Do not change or modify the aerial work platform without the prior written permission of the manufacturer. If an additional device is installed on the platform or guardrail for placing tools or other materials, this will increase the platform weight and surface area or increase the load.

- Nuts, bolts and other fasteners
- Platform (including rails, floor plate, safety lock, brackets and entry door)
- Pothole guard device
- Scissor arm (pivoting) and fastener
- Platform joystick
- Personal protection equipment
- Emergency control equipment
- Operation instructions, warning and control decals

CONDUCTING A PRE-OPERATION INSPECTION

Before starting the machine, check whether it meets the following requirements:

- Ensure the *Operation Manual* and *Maintenance Manual* are in good condition, legible and stored in the storage compartment on the platform.
- Make sure all labels are legible and appropriately located.
- Check for hydraulic oil leaks. Check for proper oil level. See [Inspect Hydraulic Oil Level, page 5-2](#). Add oil as needed.
- Check if the battery level is lower than 70%. See [Inspect Battery Level, page 5-3](#). Charge the battery as needed.
- Check whether the protective device in use matches the type of work performed and conforms to relevant technical standards.

INSPECTING PARTS

Before each use or work shift, check the machine for any damaged, improperly installed, loose or missing parts and unauthorized changes:

- Electrical components, wirings, cables and safety ropes
- Hydraulic power unit, fuel tank, connector, hose, hydraulic cylinder and valve block
- Storage battery pack and its connection
- Drive motor and brake
- Wheels
- Safety arm
- Limit switch and horn
- Alarms and indicator lamps

INSPECTING ENTIRE MACHINE

Inspect the entire machine for damage:

- Cracks in a weld joint or structural part
- Dents or other damage
- Severe rust, corrosion or oxidation
- Improper twisting of steel wire ropes, electric cables, hoses inside the platform
- Missing or loose structural parts and key components, including fasteners and pins for correct positioning and tightness
- The folding platform's ability to support the platform side rail and proper installation of safety pin with wire rope

INSPECT HYDRAULIC OIL LEVEL

Ensuring appropriate hydraulic oil is important for proper operation of the machine. Operating the machine with an improper hydraulic oil level can damage hydraulic components. Performing daily inspection of the hydraulic oil level will help you determine if a problem exists in the hydraulic system. Be sure to correct the problem before operating the machine.

Perform the following procedures with the platform retracted:

1. Open the door on the right side of the chassis.
2. Inspect the mark on the side of the hydraulic oil tank.
3. The hydraulic oil level should appear within the "max" and "min" mark in the hydraulic oil tank.
4. Add hydraulic oil as needed. Never overfill the tank.

Table 5-1







CUSTOMER REQUIREMENTS	HYDRAULIC OIL MARK
Normal-temperature region 0°C to 40°C (32°F to 104°F)	Mobil DTE 25 Ultra
Cold region -25°C to 25°C (-13°F to 77°F)	Mobil Unavis N 32 (-HVLP class hydraulic-oil)
High-temperature region greater than 40°C (104°F)	Mobil DTE 26 Ultra
Extremely cold region less than -30°C (-22°F)	Special programmes need to be identified.

NOTICE
<i>Different mark of hydraulic oils can be added according to customer requirements upon factory delivery, but cannot be mixed.</i>

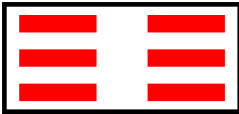
INSPECT BATTERY LEVEL

Use the diagnostic reading display on the platform to determine the battery level.

Table 5-2

PLATFORM POWER DISPLAY	POWER RATIO	DESCRIPTION
	90-100%	The battery has been fully charged.
	70%	The battery is at 70% of its capacity.
	50%	The battery is at 50% of its capacity.
	30%	The battery is at 30% of its capacity.
	20%	The battery level is at 20%, which is low. The battery requires recharging.
	10%	The battery level is at 10%, which is very low. The machine will become slow. The battery requires recharging.

6 PRE-OPERATION FUNCTION TEST

 **WARNING**

UNSAFE OPERATION HAZARD



Be sure to follow the instructions and safety rules in this manual. Failure to follow the instructions and safety rules in this manual may result in death or serious injury.

Do not operate this machine unless you have learned and practiced the rules for safely operating the machine as stated in this manual.

- **Know and understand the safety rules before continuing the next step.**
- **Avoid dangerous situations.**
- **Always check the machine before operating.**
- **Select appropriate machinery and personal protective equipment (hard hats, safety belt and gloves, etc.) for the task.**
- **Always perform a pre-operation function test before using the machine.**
- **Check the work site.**
- **Check the safety decals/ name-plate on the machine.**
- **Only use the machine according to the instructions in this manual and for its intended purpose.**

Conducting a pre-operation function test helps you discover potential problems before you start using the machine. The operator must test all machine functions according to the instructions in this manual.

Do not use a machine with problems or malfunctions. Mark the machine and do not use it if you discover any problems. Only qualified maintenance technicians can repair the machine according to the manufacturer's regulations.

After any maintenance, the operator must perform another pre-operation inspection before conducting a pre-operation function test.

PREPARING FOR A PRE-OPERATION FUNCTION TEST

NOTICE

All the pre-operation function tests must be completed within the same period..

Before beginning a pre-operation function test:

1. Select a test area that has a solid, flat, level surface.
2. Ensure the test area is free of obstacles.
3. Connect the battery to the machine if it is not already connected.

TESTING THE GROUND CONTROLLER

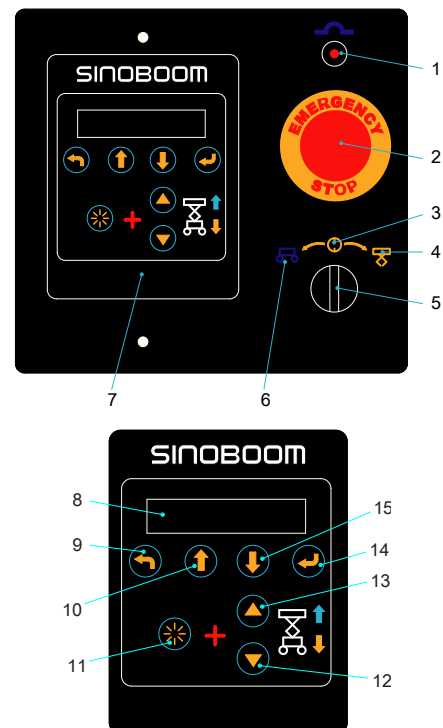

Figure 6-1 Ground controller

- | | |
|---|--------------------------|
| 1. Fuse | 9. Back key |
| 2. Emergency stop button | 10. Page up key |
| 3. Off position | 11. Enable switch |
| 4. Platform control | 12. Platform down switch |
| 5. Key switch
(Ground/Platform control
select switch) | 13. Platform up switch |
| 6. Ground control | 14. Enter key |
| 7. Controller | 15. Page down key |
| 8. Display screen | |



1. Push in the emergency stop button to the OFF position. Ensure all functions should not operate.
2. Pull out the emergency stop button to the ON position.

Enable switch



1. Move the function switch without holding the enable switch, the function should not operate.
2. Move the function switch while holding the enable switch, the function should operate.

Platform up/down function

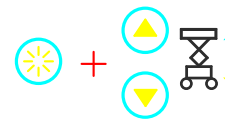

1. Simultaneously press the enable switch and the platform up switch, the platform should be up.
2. Release the enable switch or the platform up switch, the platform should not be up.
3. Simultaneously press the enable switch and the platform down switch, the platform should be down with the alarm sounding.

WARNING

UNSAFE OPERATION HAZARD

- Unless in emergency situations, never operate from the ground control console if there are still persons on the platform.
- Never operate the machine if any control handle or switch that controls the platform movement is not returned to the OFF position after being released.

Ground/Platform select switch

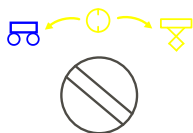

1. Push the emergency stop button on the ground controller and platform controller to the ON position.
2. Turn the key switch to the ground control position.
3. Ensure the relevant indicator light comes on and no error message appears.

Emergency stop button

TESTING THE PLATFORM CONTROLLER (SINOBOOM)

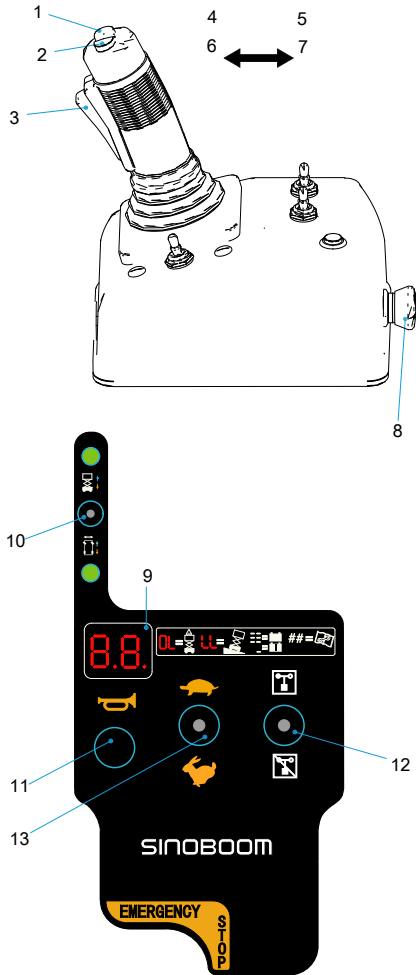

Figure 6-2 Platform controller (SINOBOOM)

- | | |
|------------------|--|
| 1. Steer right | 8. Emergency stop button |
| 2. Steer left | 9. Display screen (to display battery level and fault codes) |
| 3. Enable switch | 10. Lift, drive & steer function enable switch |
| 4. Platform up | 11. Horn |
| 5. Platform down | 12. Indoor/outdoor mode select switch |
| 6. Drive forward | 13. Drive high/low speed select switch |

7. Drive reverse

Note: Refer to the *Fault Diagnosis* section of Maintenance Manual for the fault codes displayed on the screen.

⚠ WARNING

UNSAFE OPERATION HAZARD

- Unless in emergency situations, never operate from the ground controller if there is any person on the platform.
- Never operate the machine if any control joystick or switch that controls the platform movement is not returned to the OFF position after being released.
- Do not remove, modify or disable the footswitch (if equipped) by adding stops or any other means to prevent death or serious injury.

Ground/Platform select switch

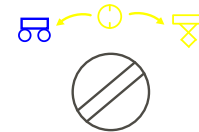

1. Pull out the emergency stop buttons on the ground and platform controllers to the ON position.
2. Turn the key switch of the ground controller to the platform control position.

Emergency stop button



1. Push the emergency stop button on the platform or ground controller to the OFF position. All functions should not work.
2. Pull out the emergency stop button on the platform and ground to the ON position.

Horn button



Press the horn button. The horn should sound.

Enable button

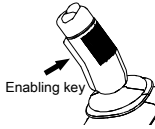

1. Test the joystick enable button.
2. With the enable button on the joystick not pressed, directly deflect forward/backward the joystick. The lift and drive functions should not work.
3. Hold the enable button on the joystick and deflect forward/backward the joystick. The corresponding function should work.

Lift function

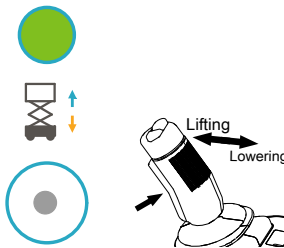

1. Move the lift-drive toggle switch forward to select lift. The "lift enabled" light should illuminate.
2. Hold the enable button on the joystick and push the joystick forward to activate the platform up function. The platform should go up and the pothole guard device should deploy.
3. Release the joystick. The platform should stop rising.
4. Hold the enable button of the joystick and pull the joystick back to activate the platform down function. The platform should go down with the alarm sounding.

Note: The lift/lower speed is in direct proportion to the travel distance of joystick.

Drive and brake functions

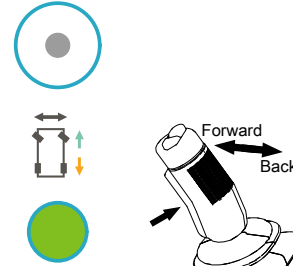

1. Move the lift-drive toggle switch backward to select drive. The "drive enabled" light should illuminate.
2. Hold the enable button of the joystick and slowly push the joystick forward until the machine begins to drive forward, then return the joystick to the center position. The machine should reduce speed and then stop.
3. Hold the enable button of the joystick and slowly pull it back until the machine begins to drive reverse, then return the joystick to the center position. The machine should reduce speed and then stop.

Note: The drive speed is in direct proportion to the travel distance of joystick.

NOTICE

The brake must be able to hold the machine at any slope the machine is able to climb.

Steer function

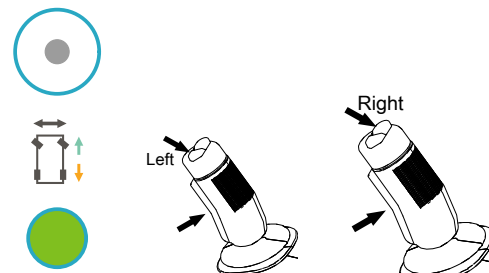

1. Move the lift-drive toggle switch backward to select drive and steer. The "drive enabled" light should illuminate.
2. Hold the enable button on the joystick, and press on the left side of the thumb rocker switch for steer function, the machine should steer left.
3. Hold the enable button on the joystick, and press on the right side of the thumb rocker switch for steer function, the machine should steer right.

Drive high/low speed select switch

⚠ WARNING

TIPPING HAZARDS



Make sure to select the low speed mode to drive when the machine tilts.

When the tilt alarm sounds, stop all functional operations except lowering, and do not continue the work unless the factor that causes the tilting is removed.



1. With the machine stowed, push forward the drive high/low speed select switch, the low drive speed should be selected.
2. With the machine stowed, pull back the drive high/low speed select switch, the high drive speed should be selected.

Indoor/outdoor mode select switch



1. With the machine stowed, push forward the indoor/outdoor mode select switch, the outdoor mode should be selected.
2. With the machine stowed, pull back the indoor/outdoor mode select switch, the indoor mode should be selected.

TESTING THE PLATFORM CONTROLLER (DTC)

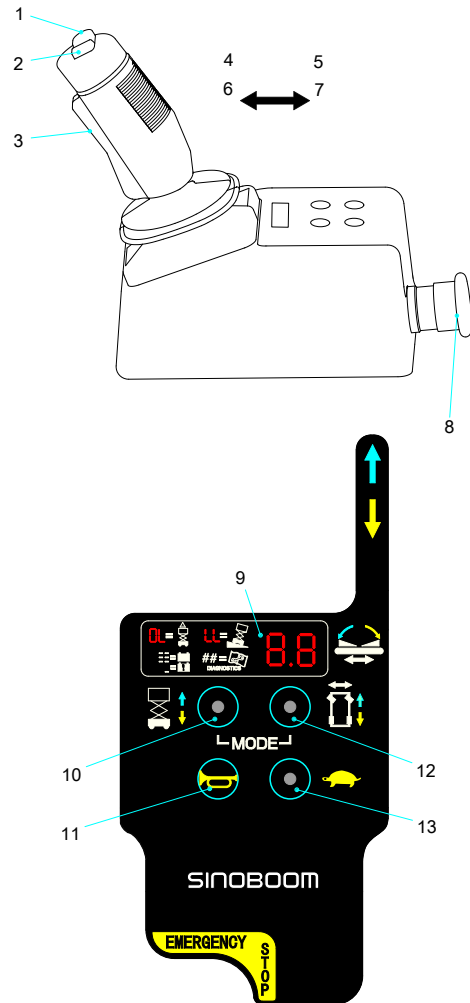
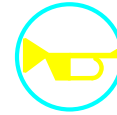

Figure 6-3 Platform controller (DTC)

- | | |
|------------------|--|
| 1. Steer right | 8. Emergency stop button |
| 2. Steer left | 9. Display screen (to display battery level and fault codes) |
| 3. Enable switch | 10. Lift function enable switch |
| 4. Platform up | 11. Horn |
| 5. Platform down | 12. Drive/steer function enable switch |
| 6. Drive forward | 13. Drive high/low speed select switch |

7. Drive reverse

Note: Refer to the *Fault Diagnosis* section of Maintenance Manual for the fault codes displayed on the screen.



Press the horn button. The horn should sound.

Enable button

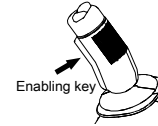

1. Test the function enable button.
2. With the enable button on the joystick not pressed, directly deflect forward/backward the joystick. The lift and drive functions should not operate.
3. Hold the enable button on the joystick and deflect forward/backward the joystick. The corresponding function should operate.

Lift function

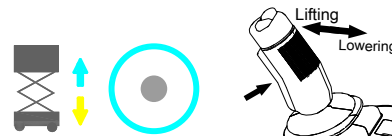

1. Press the lift function enable button. The button should illuminate.
2. Hold the enable button on the joystick and push the joystick forward to activate the platform up function. The platform should go up and the pothole guard device should deploy.
3. Release the joystick. The platform should stop rising.
4. Hold the enable button of the joystick and pull the joystick back to activate the platform down function. The platform should go down with the alarm sounding.

Note: The lift speed is in direct proportion to the travel distance of the joystick.

Drive and brake functions

WARNING

UNSAFE OPERATION HAZARD

- Unless in emergency situations, never operate from the ground controller if there are still persons on the platform.
- Never operate the machine if any joystick or switch that controls the platform movement is not returned to the OFF position after being released.
- Do not remove, modify or disable the footswitch (if equipped) by adding stops or any other means to prevent death or serious injury.

Ground/Platform select switch

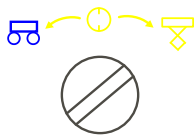

1. Pull out the emergency stop buttons on the ground and platform controllers to the ON position.
2. Turn the key switch of the ground controller to the platform control position.

Emergency stop button



1. Push the emergency stop button on the platform or ground controller to the OFF position. All functions should not operate.
2. Pull out the emergency stop button on the platform and ground to the ON position.

Horn button

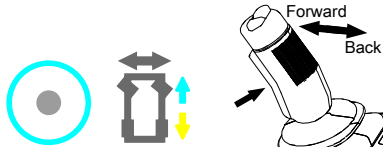

1. Press the drive/steer function button. The button should illuminate.
2. Hold the enable button of the joystick and slowly deflect the joystick forward until the machine begins to drive forward, then return the joystick to the center position. The machine should reduce speed and then stop.
3. Hold the enable button of the joystick and slowly deflect it backward until the machine begins to drive forward, then return the joystick to the center position. The machine should reduce speed and then stop.

Note: The drive speed is in direct proportion to the travel distance of the joystick.

NOTICE

The brake must be able to hold the machine at any slope the machine is able to climb.

Steer function

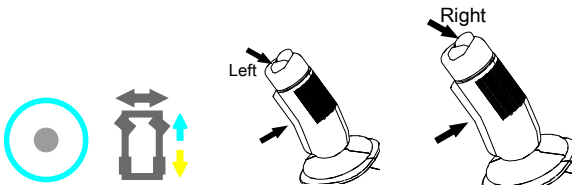

1. Press the drive/steer function button. The button should illuminate.
2. Hold the enable button on the joystick, and press on the left side of the thumb rocker switch for steer left function, the machine should steer left.
3. Hold the enable button on the joystick, and press on the right side of the thumb rocker switch for steer right function, the machine should steer right.

Drive high/low speed select button

WARNING

TIPPING HAZARDS



Be sure to select the low speed mode to drive when the machine tilts.

When the tilt alarm sounds, stop all functional operations except lowering, and do not continue the work unless the factor that causes the tilting is removed.

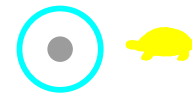

1. With the machine stowed, push the drive high/low speed select button, the button should illuminate and the machine should drive at low speed.
2. Push the button again, the button indicator light should go off and the machine should drive at high speed.

TESTING THE DRIVE SPEED

Reasonable drive speed is essential for safe operation of the machine. The drive function should respond rapidly and smoothly to the operator's operation. Within the controllable speed range, The machine should be free of shaking, shock or unusual noise.

1. Pull out the emergency stop buttons on the ground and platform controls to ON position.
2. Turn the key switch on ground controls to platform control position.

Low speed testing :

3. —SINOBOOM system : Move upwards the lift function enable switch on the platform controller, the indicator light should be on.
—DTC system : Press the lift function enable button, the button should be lit.
4. Hold the enable switch on the joystick and push forward the joystick to raise the platform to the operating position.
5. —SINOBOOM system : Move downwards the drive/steer function enable switch on the platform controller, the indicator light should be on. Hold the enable switch on the joystick and slowly push forward to full drive position, the machine should drives at 0.8km/h (0.5mph), or 123 ~ 150s for a driving distance of 30m (98ft 5in) .

—DTC system : Press the drive/steer function enable button, and hold the enable switch on the joystick and slowly push forward to full drive position, the machine should drive at 0.8km/h (0.5mph), or 123 ~ 150s for a driving distance of 30m (98ft 5in) .

NOTICE

If the time for a driving distance of 30m (98ft 5in) is less than 123s, immediately tag and remove the machine from service.

Turtle speed testing :

6. —SINOBOOM system : Move upwards the lift function enable switch on the platform controller, the indicator light should be on.. Hold the enable switch on the joystick and push backward the joystick, the platform should lower to the non-operating position.
—DTC system : Press the lift function enable button, and hold the enable switch on the joystick and slowly push backward the joystick, the platform should lower to the non-operating position.
7. —SINOBOOM system : Move downwards the drive/steer function enable switch on the platform controller, the indicator light should be on, Then move upwards the drive high/low speed select switch, the low drive speed mode should be active.



—DTC system : Press the drive/steer function enable button, and then press the drive high/low speed select button, the low drive speed button should be lit.

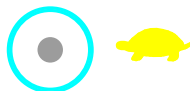

8. Hold the enable switch on the joystick and slowly push forward to full drive position, the machine should drive at 2km/h (1.24mph) , or 50 ~ 59s for a driving distance of 30m (98ft 5in) .

NOTICE

If the time for a driving distance of 30m (98ft 5in) is less than 50s, immediately tag and remove the machine from service.

High speed testing :

9. —SINOBOOM system : Move downwards the drive high/low speed select switch on the platform controller, the high drive speed mode should be active.
—DTC system : Press the drive high/low speed select button on the platform controller, the low drive speed button indicator light should be off.
10. Hold the enable switch on the joystick and slowly push forward to full drive position, the machine should drive at 4km/h (2.5mph) , or 25 ~ 30s for a driving distance of 30m (98ft 5in) .

NOTICE

If the time for a driving distance of 30m (98ft 5in) is less than 25s, immediately tag and remove the machine from service.

TESTING THE EMERGENCY LOWERING FUNCTION

In case of power unit malfunctions, the emergency lowering function can be used to fully lower the platform as appropriate.

NOTICE

This test is performed when the platform is empty.

1. Pull out the emergency stop button on the ground and platform controls to the ON position.
2. Turn the key switch on the ground to the ground control position.
3. Press and hold both the enable button and the lift function button on the ground controls to raise the platform to full height.
4. Pull out the emergency lowering handle located at the rear of the chassis.

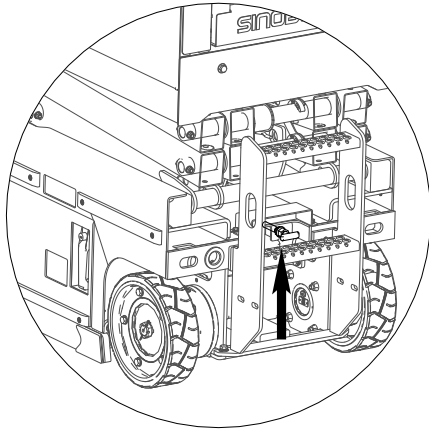

Figure 6-4

5. The platform should be down in place.

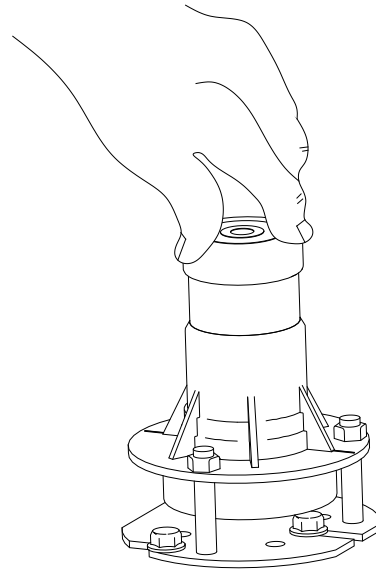



Figure 6-5

TESTING THE TILT PROTECTION FUNCTION

⚠ WARNING

UNSAFE OPERATION HAZARDS

- Do not place your hands and arms where they may become crushed or trapped.
- Do not work in or under the platform or near the scissor arms when the safety lever is not in place.

NOTICE

Perform this step while you are standing on the ground using the platform controller. Do not stand on the platform while testing this function.

1. Raise the platform to a certain height to ensure the safety arm can fully engage.
2. Set up the safety arm and properly lower the platform to ensure the safety arm supports effectively.
3. Flip the level switch to tilt the machine by 1.5 degrees in the X(left-to-right) direction. The alarm should sound.
4. Flip the level switch to tilt the machine by 3 degrees in the Y(front-to-back) direction. The alarm should sound.
5. Disengage the safety arm and fully Lower the platform.
6. Place two wooden blocks under the two wheels on the left or right side of the machine, and then drive the machine onto the blocks. The wooden block should measure as follows(L × W × H):

GTJZ0608ME: 50 mm × 100 mm × 20 mm
(2 in. × 4 in. × 0.79in.)

7. Switch the machine from drive function to lift function, and raise the platform about 2 m (6.6 ft), the tilt alarm should sound and the display indicates “LL”, the lift up and drive functions restricted, but the lowering function allowed.
8. Fully lower the platform. Switch the machine from lift function to drive function. Drive the machine off and remove the wooden blocks.
9. Place two wooden blocks under the two wheels on the front or back side of the machine, and then drive the machine onto the blocks. The wooden block should measure(L × W × H):

GTJZ0608ME: 50 mm × 100 mm × 70 mm
(2 in. × 4 in. × 2.8in.)

measure(L × W × H): 50mm×100mm×50mm
(2in×4in×2in).

- 10. Switch the machine from drive function to lift function, raise the platform about 2 m (6.6 ft), the tilt alarm should sound and the display indicates “LL”, the lift up and drive functions restricted, but the lowering function allowed.
- 11. Fully lower the platform. Switch the machine from lift function to drive function. Drive the machine off and remove the wooden blocks.

- 6. When the platform raises until the press plate of scissor comes off the carrier rod of the pothole guard, the buzzers at the ground and platform controls should sound, and the display should indicate “18”, the platform up and drive functions should be restricted, with only the platform down function operative.
- 7. Completely lower the platform and remove the wooden block.

TESTING THE POTHOLE GUARD

- 1. Raise the platform until the press plate of scissor is off the carrier rod of the pothole guard.
- 2. The pothole guard plate should automatically extend.
- 3. Push hard on the left/right pothole guard plate. Ensure the pothole guard plate cannot be flipped upward.
- 4. Lower the platform. The pothole guard plate should automatically retract.
- 5. Place a wooden block under the pothole guard and raise the platform. The wooden block should

TESTING THE WEIGHING SYSTEM (OPTIONAL)

The platform weighing system is optional. Make sure your machine has this protection function before checking this function.

- 1. Park the machine on flat, level and firm ground. Lubricate the bearings and sliding slots.
- 2. Use ground controller to lift and lower the platform without loading twice; the platform must operate in its normal state.
- 3. Lower the platform until the scissor arm is in the fully retracted state. Gradually add a load to the platform.

The test results appear in the table below:

Table 6-1

Models	Test Results
GTJZ0608ME	<p>When the weight does not exceed 230 kg (507 lb), ensure that the platform is able to lift to the highest position.</p> <p>When the platform load is greater than or equal to 275 kg (606 lb), if the platform lifting height is greater than 1 m (3.3 ft) or 10% of the height that can be lifted (use the greater number), several things will happen. The overload indicator lamp will illuminate, an alarm will sound, and the work platform will not be able to move. Once you remove the excess weight, the work platform will be able to move again.</p>

NOTICE

When the temperature of hydraulic oil is low, the viscosity will increase, which will have a significant impact on the pressure detection. If the environmental temperature difference between the terminal customer and the machine manufacturer factory delivered by the new machine $\geq 10^{\circ}\text{C}$ (50°F), or if the hydraulic oil temperature is lower than 15°C (59°F), an alarm failure occurs when the rated load is lower than the standard rated load (the "OL" symbol appears on the platform controller screen or the ground controller screen), please re-calibrate the weighing sensor.

7 OPERATING THE MACHINE

WARNING



UNSAFE OPERATION HAZARD

Be sure to follow the instructions and safety rules in this manual. Failure to follow the instructions and safety rules in this manual may result in death or serious injury.

Do not operate this machine unless you have learned and practiced the rules for safely operating the machine as stated in this manual.

- Know and understand the safety rules before continuing the next step.
- Avoid dangerous situations.
- Always check the machine before operating.
- Select appropriate machinery and personal protective equipment (hard hats, safety belt and gloves, etc.) for the task.
- Always perform a pre-operation function test before using the machine.
- Check the work site.
- Check the safety decals/ name-plate on the machine.
- Only use the machine according to the instructions in this manual and for its intended purpose.

This section provides specific instructions for all the aspects of machine operation. The operator is responsible for following all the safety rules and instructions in this manual.

Use this machine to transport people and tools to the workplace. It is unsafe and dangerous to use this machine for purposes other than what is stated in this manual.

Only trained and authorized personnel may operate the machine. If more than one operator uses the same machine at different times of the same work shift, they must all be qualified operators and follow all the safety rules and instructions in this **Operation Manual**.

Each new operator must perform the pre-operation inspection, pre-operation function test, and workplace checks before using the machine.

EMERGENCY STOP

1. Push in the emergency stop buttons on the platform and ground controllers to OFF, and all functions will be inoperative.
2. Pull out the handle of the power disconnect plug assembly on the left door of chassis, and all functions will be inoperative. See the following figure for the positions of the power disconnect plug and handle.

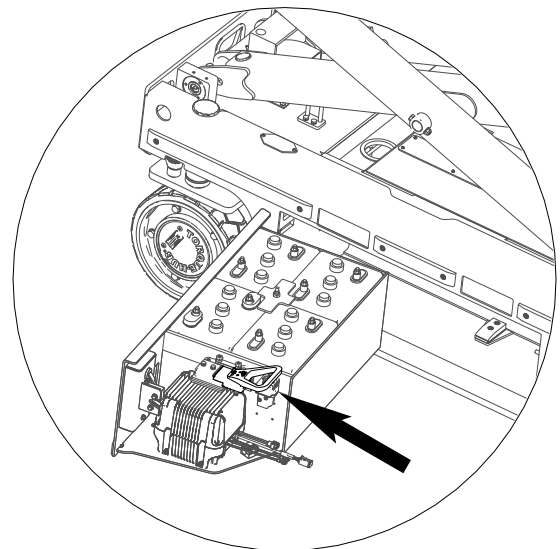

Figure 7-1 Power disconnect plug assembly

3. To restore operating any function, return the emergency stop buttons and power disconnect switch to their original positions.

NOTICE

If the platform controller displays the number "02", push in the emergency stop button immediately.

USING THE EMERGENCY LOWERING FEATURE

Pull out the emergency lowering handle to activate the machine's emergency stop function.

See [Testing the Emergency Lowering Function, page 6-8](#) for the emergency lowering handle position.

EMERGENCY TOWING/ DRAGGING

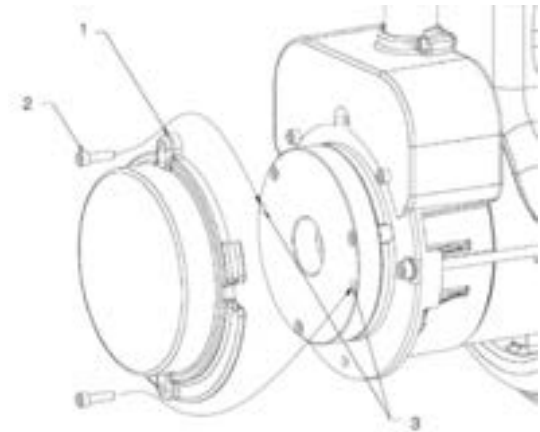

Figure 7-2 Drive motor

WARNING

UNSAFE OPERATION HAZARD

- Unless in case of emergency situations, machine malfunction, power loss or loading/unloading, it is strictly prohibited to tow or drag the machine.
- When towing/dragging the machine, there should be no person on the platform.
- Before towing/dragging the machine, ensure that the machine is in stowed position with the turntable securely locked and platform free of any tools or objects.
- Do not tow/drag the machine with the engine started or the drive hub engaged.
- The machine must be on a level surface or secured before releasing the brake.
- The towing/dragging of the machine must follow the local laws and traffic rules.

The machine needs towing/dragging in case of an emergency, machine malfunction or power loss. There are two methods to release the brake:

Method 1:

1. Chock the wheels from rolling.
2. Ensure the path of travel is clear of obstructions.
3. Remove the two end cap bolts and brake cover on the drive motor.

Table 7-1

NO.	DESCRIPTION
1	Brake cover
2	Brake end cap bolts
3	Bolt hole

4. Insert the end cap bolts into the two bolt holes on the brake housing.
5. Tighten the end cap bolts, the brake on the drive motor will disengage.
6. Repeat the above procedures onto the other drive motor. After the brakes on the both drive motors are disengaged, the machine allows moving by human power.
7. After the towing is completed, chock the wheels and remove the end cap bolts.
8. Re-install the brake cover and end cap bolts to the original position.
9. Remove the chocks as needed.

Method 2:

DTC system

1. Chock the wheels from rolling.
2. Ensure the path of travel is clear of obstructions.
3. Turn the key switch to the ground controls.
4. Pull out the emergency stop button on the platform controller to the ON position.
5. Pull out the emergency stop button on the ground controller to the ON position, and meanwhile press the Enter key, the ECU menu selection mode will be shown on the display..
6. Press the Page Down key until the display shows "Machine Mode", then press the Enter button.

7. Press the Page Down key until the display shows "Brake Release", then hold the Enter key for 5s.
8. When the message "Brake Is Released" shows on the display, and the buzzer sounds continuously, the brake is released successfully.
9. The machine allows moving by human power.
10. After the towing is completed, re-energize the machine, the brake can operate properly.
11. Remove the chokes as needed.

SINOBOOM system

1. Chock the wheels from rolling.
2. Ensure the path of travel is clear of obstructions.
3. Pull out the emergency stop button on the platform controller to ON position.
4. Pull out the emergency stop button on the ground controller to the ON position, and meanwhile press the Enter key, the adjustment screen will show on the display..
5. Press the Page Down key until the display shows "System Setting", then press the Enter key.
6. Press the Page Down key until the display shows "Brake Release", then hold the Enter key for 5s.
7. When the message "Brake Is Released" shows on the display, the brake is released successfully.
8. The machine can be moved by human power.
9. After the towing is completed, re-energize the machine, and the brake can operate properly.
10. Remove the chokes as needed.

NOTICE

The allowable towing speed is 3km/h (1.9mph).

OPERATION FROM GROUND

WARNING

UNSAFE OPERATION HAZARD



- Unless in emergency situations, do not operate from the ground controller when there are personnel in the platform.
- Do not operate the machine if any control handle or switch is not returned to off position after being released.

Before operating the machine:

1. Turn the key switch on the ground controller to the ground control position.
2. Pull out the emergency stop button on the ground controller to the ON position.
3. Ensure the battery is properly connected.

Platform up/down :

Simultaneously hold the enable switch and the platform up/down switch to raise/lower the platform.

To drive :

The drive function cannot be operated from the ground controller.

To steer :

The steer function cannot be operated from the ground controller.

OPERATION FROM PLATFORM

WARNING

UNSAFE OPERATION HAZARD



- Unless in emergency situations, do not operate from the ground controller when there are personnel in the platform.
- Do not operate the machine if any control handle or switch is not returned to off position after being released.

SINOBOOM SYSTEM

Before operation :

1. Turn the Ground/Platform select switch on the ground controller to Platform.
2. Pull out the red emergency stop buttons on both the ground and platform controllers to the ON position.
3. Ensure the battery is well connected.

To position platform :

Move upwards the lift function enable switch and hold the enable switch on the joystick and push forward/backward the joystick to raise/lower the platform.

To drive :

1. Move downwards the drive/steer enable switch and hold the enable switch on the joystick and push forward/backward the joystick to drive the machine forward/backward.
2. Speed up: slowly move the joystick off center.
3. Speed down : slowly move the joystick toward center.
4. Stop : return the joystick to center or release the enable switch.

When the boom is in operating position, the drive speed of the machine will be restricted.

The battery condition will affect the machine performance. When the platform display indicates a low battery level, the drive speed and lift speed of the machine will go down.

To steer :

Move downwards the drive/steer enable switch and hold the enable switch on the joystick and press the steer left/right button to steer the machine left/right.

To select drive speed :

1. Turn the key switch on the ground controller to Platform.
2. Pull out the red emergency stop buttons on both the ground and platform controllers to the ON position.
3. Ensure the battery is well connected.

To position platform :

Press the lift function enable button and hold the enable switch on the joystick and push forward/backward the joystick to raise/lower the platform.

To drive :

1. Press the the drive/steer enable button and hold the enable switch on the joystick and push forward/backward the joystick to drive the machine forward/backward.
2. Speed up: slowly move the joystick off center.
3. Speed down : slowly move the joystick toward center.
4. Stop : return the joystick to center or release the enable switch.

When the boom is in operating position, the drive speed of the machine will be restricted.

The battery condition will affect the machine performance. When the platform display indicates a low battery level, the drive speed and lift speed of the machine will go down.

To steer :

Press the drive/steer enable button and hold the enable switch on the joystick and press the steer left/right button to steer the machine left/right.

To select drive speed :

WARNING

TIPPING HAZARD

The machine must be driven at low speed when tilted.
When the machine tilt alarm sounds, do not operation any function except lowering, and not until the tilting factor is eliminated can the machine be used again.

1. With machine stowed, the machine can be driven in high/low speed mode.
2. Move the drive high/low speed select switch to select the desired drive speed. Move upwards the drive high/low speed switch, the low drive speed mode is active. Move downwards the drive high/low speed switch, the high drive speed mode is active.

When the machine is in the operating position, the machine can only be driven at the working speed. Moving the drive high/low speed select switch will not enable the high drive speed mode.

Indoor/outdoor mode :

For the setting method of the indoor/outdoor mode, please see **Setting method of indoor/outdoor mode.**

DTC SYSTEM

Before operation :

WARNING

TIPPING HAZARD

The machine must be driven at low speed when tilted.
When the machine tilt alarm sounds, do not operation any function except lowering, and not until the tilting factor is eliminated can the machine be used again.

1. With machine stowed, the machine can be driven in high/low speed mode.
2. Press the drive high/low speed select switch to select the desired drive speed. When the low drive speed indicator light is on, the low drive speed mode is active. When the low drive speed indicator light is off, the high drive speed mode is active.

When the machine is in the operating position, the machine can only be driven at the working speed. Pressing the drive high/low speed select switch will not enable the high drive speed mode.

Indoor/outdoor mode :



For the setting method of the indoor/outdoor mode, please see **Setting method of indoor/outdoor mode**.

OPERATING WITH THE PLATFORM CONTROLLER ON THE GROUND

Before operating the machine with the platform controller on the ground:



1. Keep a safe distance between the operator, machine and fixed platform.
2. Pay attention to the traveling direction of the machine when using the controller.

EXTENDING/RETRACTING THE PLATFORM

 WARNING	
	<p style="text-align: center;">UNSAFE OPERATION HAZARD</p> <ul style="list-style-type: none"> • While the platform is extending, do not stand on the platform extension. The platform extension can be secured on three slots, do not operate on the platform extension that has not been secured.

1. Press down the pedal, grasp the rail of extension platform and push to extend the platform.
2. Press down the pedal, grasp the rail of extension platform and pull to retract the platform.
3. Release the pedal, insert the extension platform end into the slot to secure the extension platform.

FOLDING/UNFOLDING THE RAILS

 WARNING	
	<p style="text-align: center;">UNSAFE OPERATION HAZARD</p> <ul style="list-style-type: none"> • Do not fold the rails while the machine is working. • Fold/unfold the rails only when the machine is stowed and extension platform fully retracted.

 WARNING	
	<p style="text-align: center;">CRUSH HAZARD</p> <ul style="list-style-type: none"> • Do not allow hands or arms to get close to any place that may have crush hazards.

The platform rails can be foldable for convenient transportation. The rail folding system consists of the fold-down rails of the extension platform and the fold-down rails of the fixed platform.

To fold the rails:

1. Remove the platform control box and support.
2. Remove the both wire rope safety pins at the front end of the extension platform. Fold the front end rail of extension platform. Do not reach your hands into the place that may have pinch hazards.
3. Fold down the rails on both sides. Do not reach your hands into the place that may have pinch hazards.
4. Remove the both wire rope safety pins at the rear end of the fixed platform.
5. Carefully open the door and stand on the ladder or ground.
6. Fold down the door and the side rails at the entry door as a piece. Do not reach your hands into the place that may have pinch hazards.
7. Fold the side rails. Do not reach your hands into the place that may have pinch hazards.

To unfold the rails:

Operate in reverse order as stated above to unfold the rails. Ensure the wire rope safety pins are properly secured after unfolding the rails.

DRIVING ON A SLOPE

Before driving on a slope:

1. Determine the climbing ability of the machine.

GTJZ0608ME: 25% (14°)

2. Ensure the platform is fully folded.
3. Ensure that the slope where you plan to drive is less than the angle of the machine's climbing ability.

NOTICE

Climbing ability refers to the maximum permissible percentage of the slope when the machine is on solid ground with sufficient traction and the platform is carrying only one person. As the weight of the machine's platform increases, the machine's climbing capacity reduces.

To determine the slope:

1. Use a carpenter's rule, a straight board (longer than 1 m [3.3 ft]), and a tape measure.

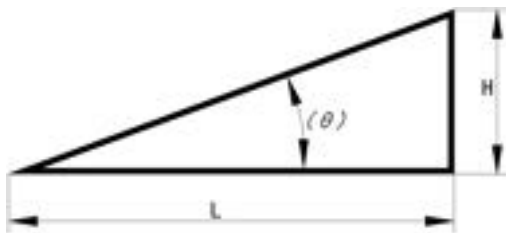

Figure 7-3

2. Measure the height and length/distance of the slope.
3. The slope measurement consists of the numbers for the height and length/distance x 100%.

NOTICE

To avoid the wheel from dangling, the machine should not be driven for more than 2 minutes on slopes with the maximum climbing capacity allowed, and be sure that the temperature of the motor shell does not exceed 70 °C.

acid maintenance-free batteries are free of maintenance.

WARNING

UNSAFE OPERATION HAZARD



- Be sure to read and follow the manufacturer's recommendations on how to use and maintain the battery.
- The battery contains sulfuric acid and can generate explosive mixture of hydrogen and oxygen, Keep the battery far away from spark, fire (including cigarette and smoke) to avoid explosion.
- Do not charge the battery under direct sunshine.
- Charge the battery on a well-ventilated site.
- Do not expose the battery on charging to water or rain.
- Charge the battery at the proper voltage as indicated on the decal.
- If the battery is topped by a cover or other objects, remove them before charging to ensure the flammable gas produced during charging can be fully dispersed. Do not close the cover until 30 minutes after the charging is completed. The charging site should be well-ventilated and if charged indoors, a fan can be used for better ventilation.

CHARGING THE BATTERY

The battery falls into 3 types: lead acid, lead acid maintenance-free and lithium batteries. The lithium and lead

⚠ WARNING



DAMAGED BATTERY HAZARD



- Only use the charger provided by the manufacturer, and plug only to a grounded 3-phase power outlet.
- Do not reverse the positive and negative of the battery.
- Charge as soon as possible once the battery is depleted.
- Do not deplete the battery more than 80% of the standard capacity, as frequent over-depletion of the battery will shorten the battery life.
- The battery must be charged fully, as intermittent charging will bring damage to the battery.

⚠ WARNING

ELECTROCUTION HAZARD

- Contact with live circuit may cause serious injury or death. Be sure to wear goggles, gloves and protective clothing.
- Remove all rings, watches and other jewelry.

NOTICE

- The machine is delivered with a battery level less than 80%, therefore it is recommended that the battery be fully charged after receiving the shipment.
- The charging current should not exceed the max allowable charging current.
- The charging voltage should not exceed the max allowable voltage as specified on the battery.
- The charging temperature range is -10°C~45°C. If a charge heating system is available, the temperature range is -20°C~45°C.

Charging the lead acid battery requiring maintenance

1. Disconnect the cables wiring the battery to the machine.
2. Remove the vent cap of the lead acid battery.

3. Measure the gravity of the electrolyte, if less than 1.13, it indicates the battery has been over-depleted (more than 80%). Be aware that repeated over-depletion can shorten the battery life.
4. Measure the temperature of electrolyte, if more than 45°C, please let the battery to cool down before moving on the next step.
5. Install the vent cap.
6. If equipped with an automatic water refill system, connect the water hose.
7. Connect the charger to a grounded AC circuit. The indicator light will be on after fully charged.
8. After charging, disconnect the charger.
9. If equipped with an automatic water refill system, disconnect the water hose after completed.
10. If not equipped with an automatic water refill system, check the electrolyte level, the level is lower than the allowable height (lower than the water filler plug), wear gloves to add distilled water or deionized water to the standard level (1-2cm above the Min. level of the water filler plug). Never add any acid solution.

⚠ WARNING

CHEMICAL BURN HAZARD



- Avoid the battery acid escaping out or contact with unprotected skin, if does, clean with a large amount of clear water and seek medical assistance.
- If excessive distilled water is added, draw out until it reaches the proper level. If excessive distilled water is added and the electrolyte escapes, use baking soda mixed with water to neutralize the acid.

11. Do not add water before charging, otherwise it may cause the acid to escape.
12. Wire the battery to the machine, and the machine is ready for use.

Charging the maintenance-free battery

1. Disconnect the cables wiring the battery to the machine.
2. Connect the charger to a grounded AC circuit. The indicator light will be on after fully charged.
3. Disconnect the charger from the AC circuit.
4. Wire the battery to the machine, and the machine is ready for use.

CHARGER OPERATING INSTRUCTIONS

Extension cords must be 3-wire cord no longer than 30m (100') at 10 AWG or 7.5m (25') at 16 AWG, per UL guidelines.

DELTA-Q CHARGER

The charger may become hot during charging. Use hand protection to safely handle the charger during charging.



Figure 7-4

1. The USB Host Port allows data to be transferred to and from the charger using a standard USB flash drive, including the downloading of charge tracking data and updating of the charger’s software and / or charge profiles.
2. The Charging Output Indicator means that the charger output is active, and there is a potential risk of electric shock.
3. The Charge Profile / Error Display shows one of four possible codes to indicate different conditions:
 - ‘F’ codes meaning that an internal fault condition has caused charging to stop.
 - ‘E’ codes meaning that an external error condition has caused charging to stop.
 - ‘P’ code meaning that the charger programming mode is active.
 - ‘USB’ code meaning that the USB interface is active, and the USB flash.
4. The Select Charge Profile Button is used to select a charge profile from those stored on the charger. Up to 25 charge profiles can be stored. See the “Selecting A Charge Profile” section for instructions.

GREEN POWER CHARGER

LED indicator light and digital display:

Connect the charger to the battery, and plug the charger to a civil power outlet, the charger will get into the charging mode. The digital display will show the following in turn: AC XXX(current AC input voltage), CPU X.XX(software version of the charger) ; b**(shows the current charging curve code)

Charging state indicator lights and digital display:

- % capacity percentage indicator light : digitally show the current percent , for example : 10 20 30... 100 (%).
- V charge voltage indicator light : show the current charge voltage, digitally show the specific voltage value, for example : 24.0 (V).
- A charge current indicator light : show the current charge current, digitally show the specific charge current value, for example : 36.0 (A).

SELECTING A CHARGE PROFILE

DELTA-Q CHARGER

1. Disconnect AC input from the charger, or from the wall outlet. Wait 30 seconds for the input relay to open.



Figure 7-5

2. While reconnecting AC input, press and hold the Select Charge Profile Button. Hold the button (- approximately 10 seconds) through the light check function until Error Indicator is on (in amber) and Battery Charging Indicator (in green) starts flashing.



Figure 7-6

3. Press and release the Select Charge Profile Button to advance through the charge profiles. The selected charging profile will be displayed up to three times (e.g. "P-0-1-1" for Profile 11).*

* Process will time out and profile will remain unchanged if there is 15 seconds of inactivity, a profile number is allowed to display three times, or if AC power is cycled.



Figure 7-7

4. Once desired charging profile is displayed, press and hold the Select Charge Profile button for 10 seconds to confirm selection and exit Profile Selection Mode. When the charge profile is confirmed, the Error Indicator and Battery Charging Indicator lights will turn off, while the blue AC Power Indicator stays lit. At this point, the button can be released.
5. Press the Select Charge Profile Button to check that the desired profile is selected.

Table 7-2

Curve codes	Battery models
Algo ID: 0-0-3	Rocket L105
Algo ID: 0-0-3	Rocket L125
Algo ID: 0-0-3	Rocket L1275
Algo ID: 0-0-3	Trojan 150~250 Ah
Algo ID: 0-4-2	Discover AGM 80~150Ah
Algo ID: 0-4-3	Discover AGM 200~400Ah

Note: the default curve code of Delta-Q IC650 is Algo ID: 0-0-3.

GREEN POWER CHARGER

Note : The battery curve of the charger for the lithium battery needs no setting, the following instructions are only for the lead acid battery charger only.

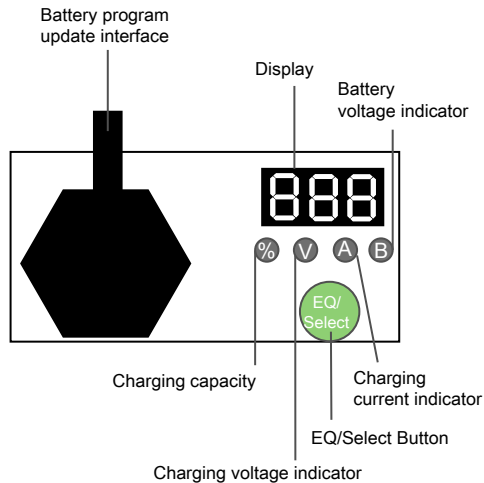

Figure 7-8

To switch the curve:

1. Press and hold the Select key for 5s and release, the display will indicate the current curve code.
2. Press gently for 1s and release to switch the charging curve codes.
3. After selection of charging curve code, press and hold Select key for 5s, the charging curve code will flash quickly, release the key, and the battery curve has been configured.
4. Repeat the steps above if re-charge is needed.

To enter EQ mode manually:

1. Press and hold Select key for 10s, when the display shows EQ in quick flashing, release the key and the charger has been set in EQ mode.
2. To exit the EQ mode, likewise, press and hold the Select key for 10s, when the display shows OFF in quick flashing, release the key and the charger will exit the EQ mode.

Charger in-built curve codes and respective battery models

Table 7-3

Curve codes	Battery models
B02	Trojan T105
B04	Discover AGM
B05	US Battery Flooded
B07	Trojan T125
B11	Trojan T1275 (two in series and two in tandem)

Note: the default curve code is B04.

8 TRANSPORTING AND LIFTING THE MACHINE

WARNING

TRANSPORTATION AND LIFTING HAZARD



- Use a forklift or crane with the proper lifting capacity to lift the machine. Use good judgment and a planned movement to control the machine.
- Transport vehicles must be parked on level ground.
- Be sure to prevent the transportation vehicle from moving when loading the machine. Refer to [1 Machine Specifications, page 1-1](#).
- Ensure that the vehicle capacity, loading surface, belts or ropes are sufficient to support the weight of the machine.
- Be sure the machine is on a horizontal plane or fixed before releasing the brakes.
- When removing the wire rope safety pin, prevent the guardrail from falling. The guardrail must be held tight at all times when descending.
- Never transport people on the machine while the machine is being towed or while the machine is engaged in towing or lifting operations.
- When using a forklift or crane to lift the machine, pay attention to prevent the machine from colliding with nearby objects.
- Lock the wheels of the machine after it has been installed to prevent the machine from rolling.

NOTICE

Do not pull/drag the machine unless an emergency, failure or loss of power occurs. Refer to [Emergency Towing/Dragging, page 7-2](#).

LIFTING THE MACHINE WITH A FORKLIFT

Follow these requirements when lifting the machine by forklift:

1. Make sure the platform extension, controller and chassis components are stable. Remove all loose parts from the machine.
2. Fully lower the platform. Keep the platform down during transportation.
3. Use the forklift slots on the rear or side of the chassis

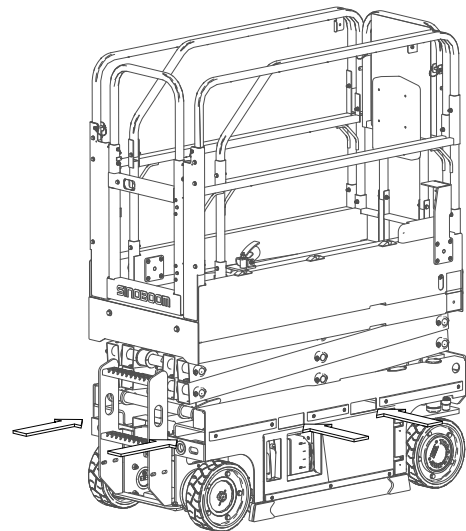

Figure 8-1

4. The forklift fork must align with the position of the forklift slots.
5. Drive forward to the fork frame to insert it fully into the slots.
6. Lift the machine by 16 in. (0.4 m) and then tilt the fork backward slightly to keep the machine stable.
7. Keep the machine horizontal when lowering the fork frame.

NOTICE

Failure to use the forklift slot while lifting machine will result in component damage.

LIFTING THE MACHINE WITH A CRANE

Follow these requirements when lifting the machine by a crane:

1. Fully lower the platform. Keep the platform down during transportation.
2. Make sure the platform extension, controller and chassis components are stable.
3. Remove all loose parts from the machine.
4. To determine the center of gravity of the machine, see the following figure.

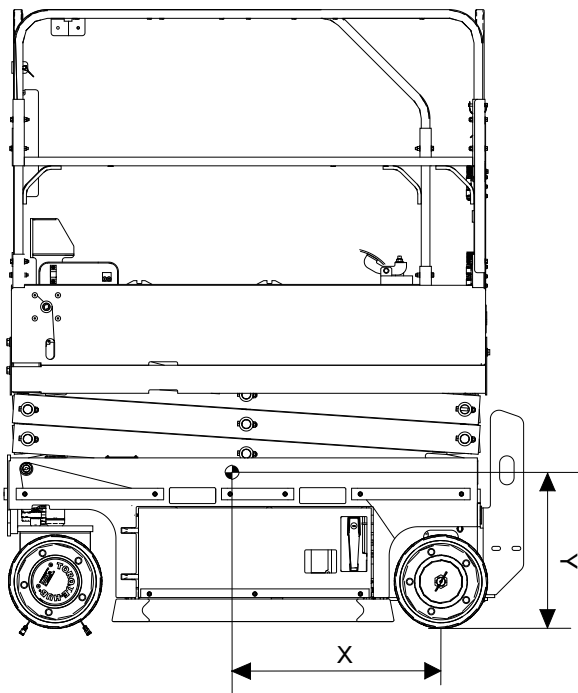

Figure 8-2

Table 8-1

Models	X	Y
GTJZ0608ME	651 mm (25.6 in.)	527 mm (20.7 in.)

5. Lift the machine according to the following figure.

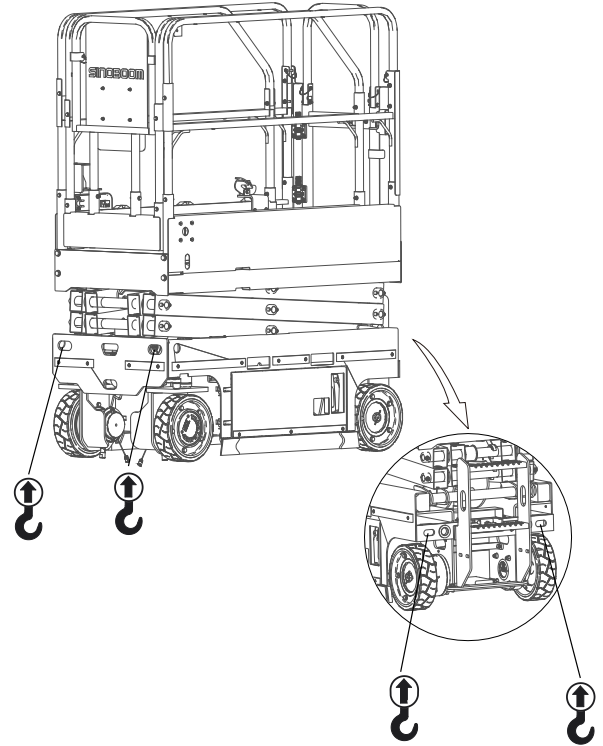

Figure 8-3

6. Only connect the rigging to the raised point specified on the machine. Adjust the rigging to avoid damaging the machine and to keep the machine horizontal.

NOTICE

To protect the platform guardrail, choose the appropriate length of spreader.

TRANSPORTING THE MACHINE

Obey the following requirements when transporting the machine using trucks or trailers:

1. Before transporting, turn the key switch of the ground controller to the OFF position and then remove the key.
2. Inspect the machine thoroughly for loose parts.
3. Ensure the rope or belt has sufficient load strength.
4. Use at least two ropes or straps.
5. Adjust the rigging to prevent damage to the rope or belt.

NOTICE

During transportation, retract the extension platform so that the extension platform is secure at the slots. Ensure that the extension platform cannot extend or shake out of the main platform during transportation.

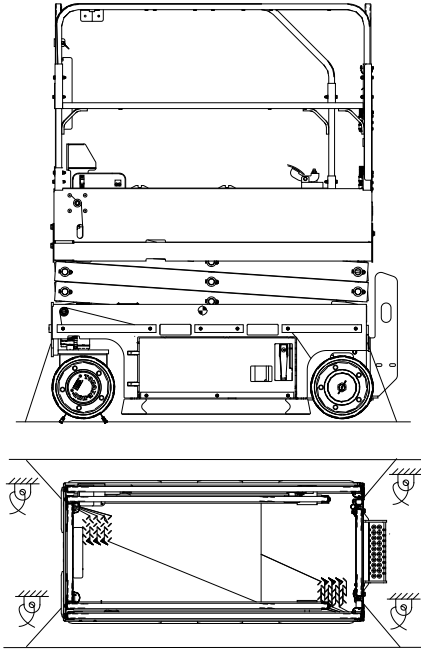
**Figure 8-4**

9 MAINTENANCE

This section provides detailed procedures for regular maintenance inspections. For further information about maintenance, please see *Maintenance Manual*.

 **WARNING**

UNSAFE OPERATION HAZARD



Failure to follow the proper maintenance may result in death, serious injury or damage to the machine.

Follow these general rules:

- Preventive maintenance procedure should be established by the user according to the manufacturer's recommendations, machine operational environment and intensity of use, which should include both the regular inspection and the annual inspection.
 - Professionally trained, qualified personnel must conduct routine maintenance inspections on this machine.
 - Daily routine maintenance inspections must occur during normal operation of the machine. Maintenance inspectors must carry out inspection and maintenance according to the repair & inspection report and must complete the repair & inspection report.
 - Regular maintenance inspections must occur by operators and at quarterly, biannual and annual intervals by qualified, trained personnel. Qualified, trained personnel must check and maintain the machine according to the repair & inspection report and must complete the repair & inspection report.
 - Immediately remove a damaged or malfunctioning machine, mark it and stop using it.
 - Repair any damaged or malfunctioning machine before operating it.
 - Keep all machine inspection records for at least 10 years or until the machine is no longer in use or as required by machine owner/company/custodian.
 - The inspection and maintenance intervals depend on the manufacturer's recommendations, and should also be appropriate to the operational conditions and environment.
 - Conduct a quarterly inspection on machines that have been out of service for a period lasting longer than three months.
- While maintaining the machine, replace any parts on the machine using the same parts or the same parts of the original machine.
 - Unless otherwise specified, perform all maintenance procedures according to the following terms and conditions:
 - Park the machine on flat, level, firm ground.
 - Keep the machine in the stowed position.
 - Ensure the key switch of the ground controller is in the OFF position and remove the key to prevent unauthorized use of the machine.
 - Place the red emergency stop button on the platform control box and ground controller in the OFF position to avoid accidental start-up of the operating system.
 - Disconnect main power switch.
 - Disconnect all DC power from the machine.
 - Lock all wheels to prevent movement of the machine.
 - Before releasing or removing the hydraulic components, release the hydraulic oil pressure in the hydraulic pipeline.

CONDUCTING A PRE-DELIVERY INSPECTION

When the machine owner/company changes, in addition to conducting a pre-delivery inspection, the corresponding inspection shall be carried out according to the maintenance schedule requirement and repair & inspection report. When conducting a pre-delivery inspection, comply with the following requirements:

1. It is the responsibility of the machine owner/company to perform a pre-delivery inspection.
2. Follow this procedure each time before delivery. Performing a pre-delivery inspection could reveal potential problems with the machine before you begin putting the machine into service.
3. Never use a damaged or malfunctioning machine. Tag the machine and do not use it.
4. Only professionally trained, qualified personnel may repair the machine and must follow the procedures as stated in *operation manual* and *maintenance manual*.

5. A competent operator must conduct daily maintenance on this machine as stated in *operation manual* and *maintenance manual*.

Before delivering the machine, complete the following record using these instructions:

1. Prepare the machine before delivery, which includes performing a pre-delivery inspection,

following maintenance procedures and performing functional inspections.

2. Use the following table to note the results. After each section is complete, mark the appropriate box.
3. Record the inspection results. If any inspection results are "NO", the machine must be stopped and re-inspected after repair is completed and marked in the box marked "inspection".

Table 9-1

PREPARE THE WORK RECORD BEFORE DELIVERY			
Model			
Serial No.			
Inspection Item	YES/Machine is in Good Condition	NO/Machine Has Damage or Malfunction	REPAIRED/Machine Has Been Repaired
Pre-operational Inspection			
Maintenance Procedure			
Functional Inspection			
Machine Buyer/ Renter			
Inspector Signature			
Inspector Title			
Inspector Company			

FOLLOWING A MAINTENANCE SCHEDULE

Regular maintenance inspections must occur daily, quarterly, biannually (every 6 months) and annually, and must be performed by the personnel qualified in the maintenance and service of the machine models involved. Use the table to help you adhere to a routine maintenance schedule.

Table 9-2

INSPECTION INTERVAL	INSPECTION PROCEDURES
Every day or every 8 hours	A
Every quarter or every 250 hours	A+B
Every half a year or every 500 hours	A+B+C
Every year or every 1000 hours	A+B+C+D

COMPLETING A REPAIR & INSPECTION REPORT

1. Divide the Repair & Inspection Report into four sections (A, B, C and D) according to the time requirements of the maintenance schedule and the maintenance procedure requirements.
2. The Repair & Inspection Report shall include the inspection table of each regular inspection.
3. Duplicate the Repair & Inspection Report template for each inspection. Store the completed tables for 10 years or until the machine is no longer in use or as required by machine owner/company/custodian.
4. Use the following table to record the results. After one item is complete, check the appropriate box.
5. Record the inspection results. If any inspection results are "NO", the machine must be stopped and re-inspected after repair is completed and the box marked "REPAIRED" shall be checked. Select the appropriate inspection procedure based on the inspection type.

Table 9-3

REPAIR & INSPECTION REPORT				
Model				
Serial No.				
Checklist A Procedures				
Items	YES/Machine is in Good Condition	NO/Machine Has Damage or Malfunction	REPAIRED/ Machine Has Been Repaired	Problem Description
A-1 Inspect All Manuals				
A-2 Inspect All Decals				
A-3 Inspect Damaged, Loose or Lost Parts				
A-4 Inspect Hydraulic Oil Level				
A-5 Inspect Hydraulic Oil Leakage				
A-6 Functional Tests				
A-7 Inspect the Battery Level				
A-8 Perform Maintenance After 30 Days				
Checklist B Procedures				
Items	YES/Machine is in Good Condition	NO/Machine Has Damage or Malfunction	REPAIRED/ Machine Has Been Repaired	Problem Description
B-1 Inspect Electric Wires				
B-2 Inspect Rim, Tire and Fasteners				
B-3 Inspect Battery				
B-4 Inspect Hydraulic Oil				
B-5 Inspect Hydraulic Tank Air Filter				
B-6 Inspect Manual Brake Release				
B-7 Inspect Emergency Lowering				
B-8 Inspect Braking Device				
B-9 Test Lift/Lower Speed				
B-10 Test Drive Speed				
B-11 Inspect Tilt Protection				

REPAIR & INSPECTION REPORT				
B-12 Inspect Pothole Guards				
Checklist C Procedures				
Items	YES/Machine is in Good Condition	NO/Machine Has Damage or Malfunction	REPAIRED/ Machine Has Been Repaired	Problem Description
C-1 Replace Hydraulic Oil Tank Air Filter				
C-2 Inspect Platform Weighing System				
C-3 Inspect Lift Limit Switch				
C-4 Inspect Staged Lowering				
C-5 Inspect Carbon Brush of Motor				
Checklist D Procedures				
Items	YES/Machine is in Good Condition	NO/Machine Has Damage or Malfunction	REPAIRED/ Machine Has Been Repaired	Problem Description
D-1 Inspect Scissor Arm Installation Bearing				
D-2 Inspect Chassis Slider				
D-3 Replace Hydraulic Oil				
User				
Inspector Signature				
Inspection Date				
Inspector Title				
Inspector Company				